

WKM DynaSeal[®] 210 and 310 Floating Ball Valves

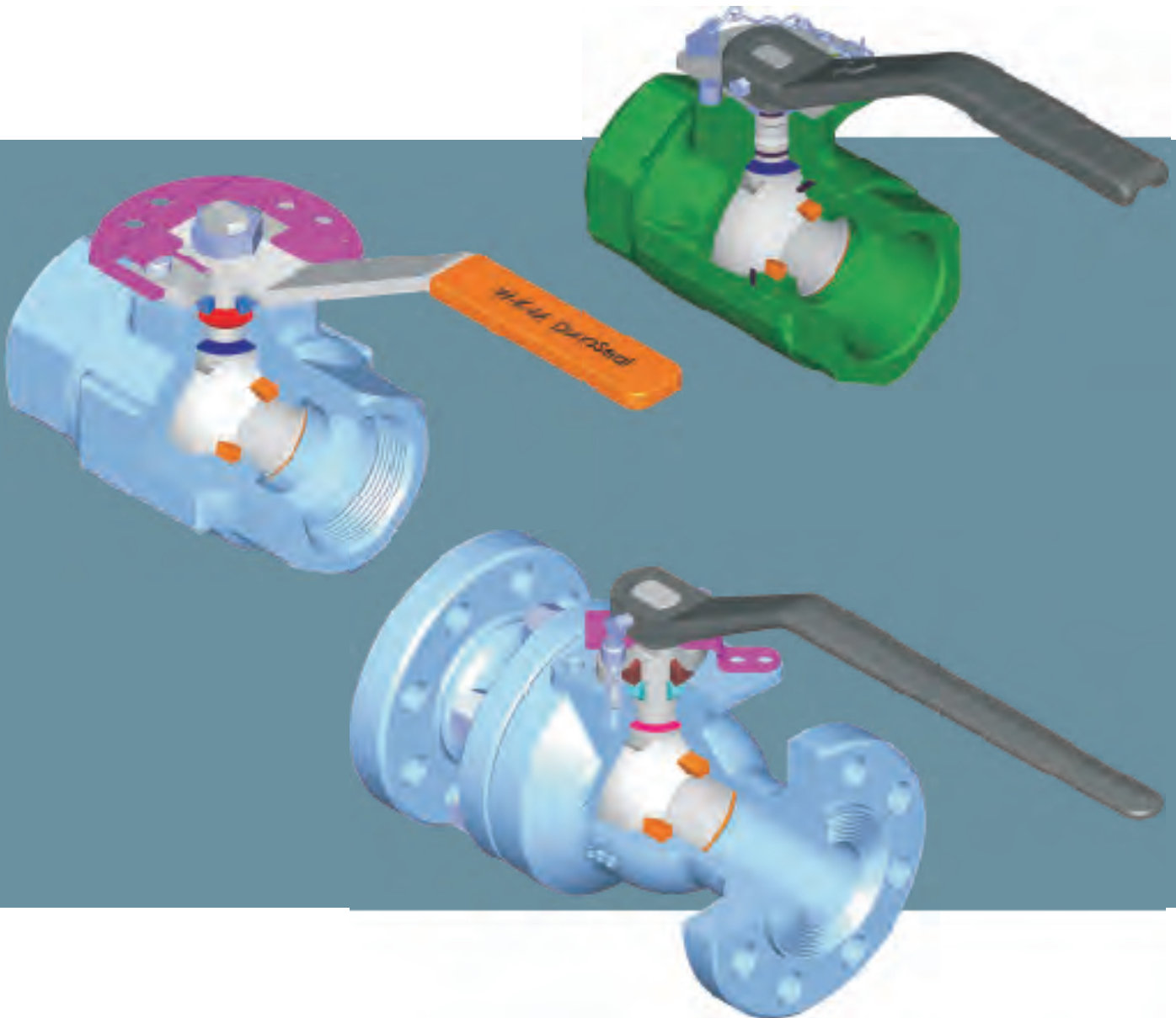

TABLE OF CONTENTS

**WKM DYNASEAL® 210
DUCTILE IRON FLOATING BALL VALVES**

How To Order	1
Features and Benefits	2 & 3
Detail View, Sizes, Standards and Specifications	4
Materials List	5
Dimensions and Weights	6

**WKM DYNASEAL® 310
FLOATING BALL VALVES**

How To Order	7 & 8
Features and Benefits	9 & 10
Exploded View	11 & 12
Trim Chart	13

DIMENSIONAL DATA

4 in. (100 mm) Reduced Port and Smaller	14 & 15
Features and Benefits	16 & 17
Exploded View	18
Trim Chart	19

DIMENSIONAL DATA

4 in. (100 mm) Full Port and Larger	20 & 21
Pressure/Temperature Charts	22 & 23
Weights	24 & 25
Flow Characteristics	25
Stem Torques	26 & 27
WKM DynaSeal Material Selection Guide	28 through 34

TRADEMARK INFORMATION	35
------------------------------------	----

WKM DYNASEAL 210 HOW TO ORDER

J0XXXXX	-	2	1	X	X	X	0	X
Base Part Number		Pressure Rating (CWP)	Body Material	Seat Trim	Seal Material	Ball & Stem		Handle

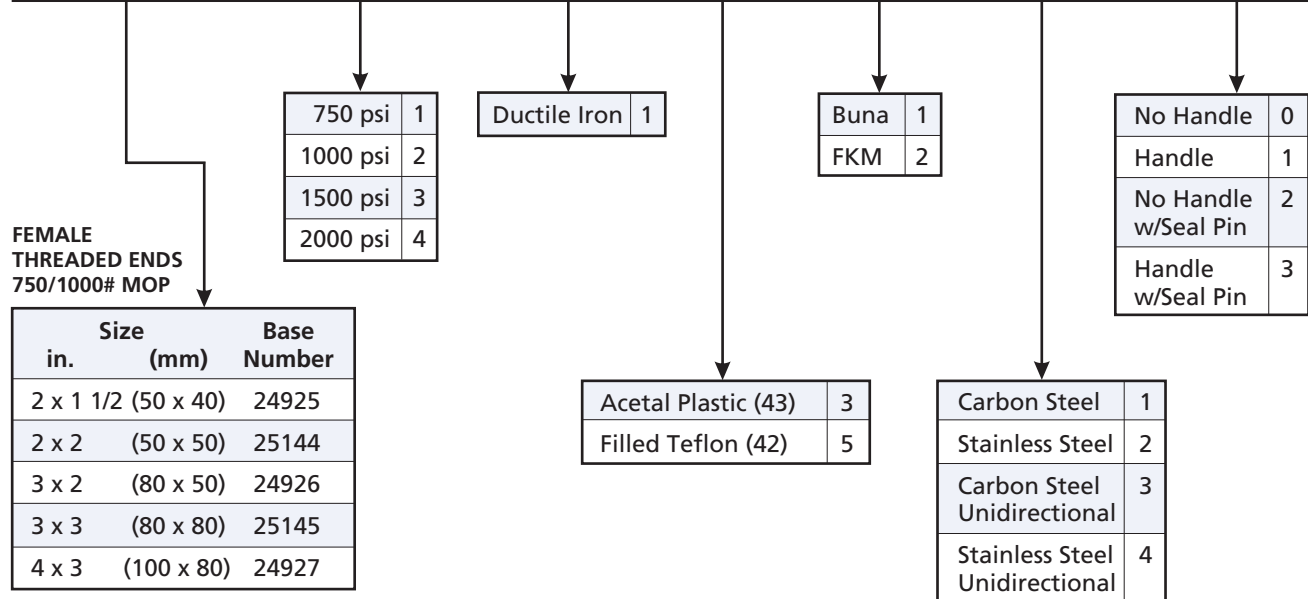

1500/2000# MOP

1 x 1	(25 x 25)	24190
2 x 1 1/2	(50 x 40)	24132
2 x 2	(50 x 50)	24056
2 1/2 x 2	(65 x 50)	24059
3 x 2	(80 x 50)	24063
3 x 3	(80 x 80)	24178*
4 x 3	(100 x 80)	24211*

* Maximum pressure rating of 1500 psi for 4 in. x 3 in. (100 mm x 80 mm) and 3 in. x 3 in. (80 mm x 80 mm).

GROOVED ENDS 750# MOP

2 x 1 1/2	(50 x 40)	25111
3 x 2	(80 x 50)	25112
4 x 3	(100 x 80)	25113

* See page 3 for details.

Examples: Standard Trim 2 in. (50 mm) J024925-2131100
 H₂S, NACE trim suffix code = standard -213220X
 = unidirectional -213240X

WKM DYNASEAL 210 FEATURES AND BENEFITS

This rugged but economical ductile iron ball valve is ideal for threaded end oilfield applications where carbon steel body material is not a requirement.

The WKM DynaSeal 210 ball valve is a two piece design with a ductile iron body and tailpiece. This valve is economical and it includes many of the premium design features found in the WKM DynaSeal 310 carbon steel ball valve.

It is available in 1 in. (25 mm) to 4 in. x 3 in. (100 mm x 80 mm) sizes. Working pressures offered are 750, 1,000, 1,500 and 2,000 psi. (See size/pressure table on page 4).

This valve is primarily used in the oilfield market for the following applications.

- Production wing valves on low pressure gas wells
- Production flow lines
- Production gathering systems for water, oil and gas
- Gas blow down service
- Tank batteries for storage or production
- Frac water tanks

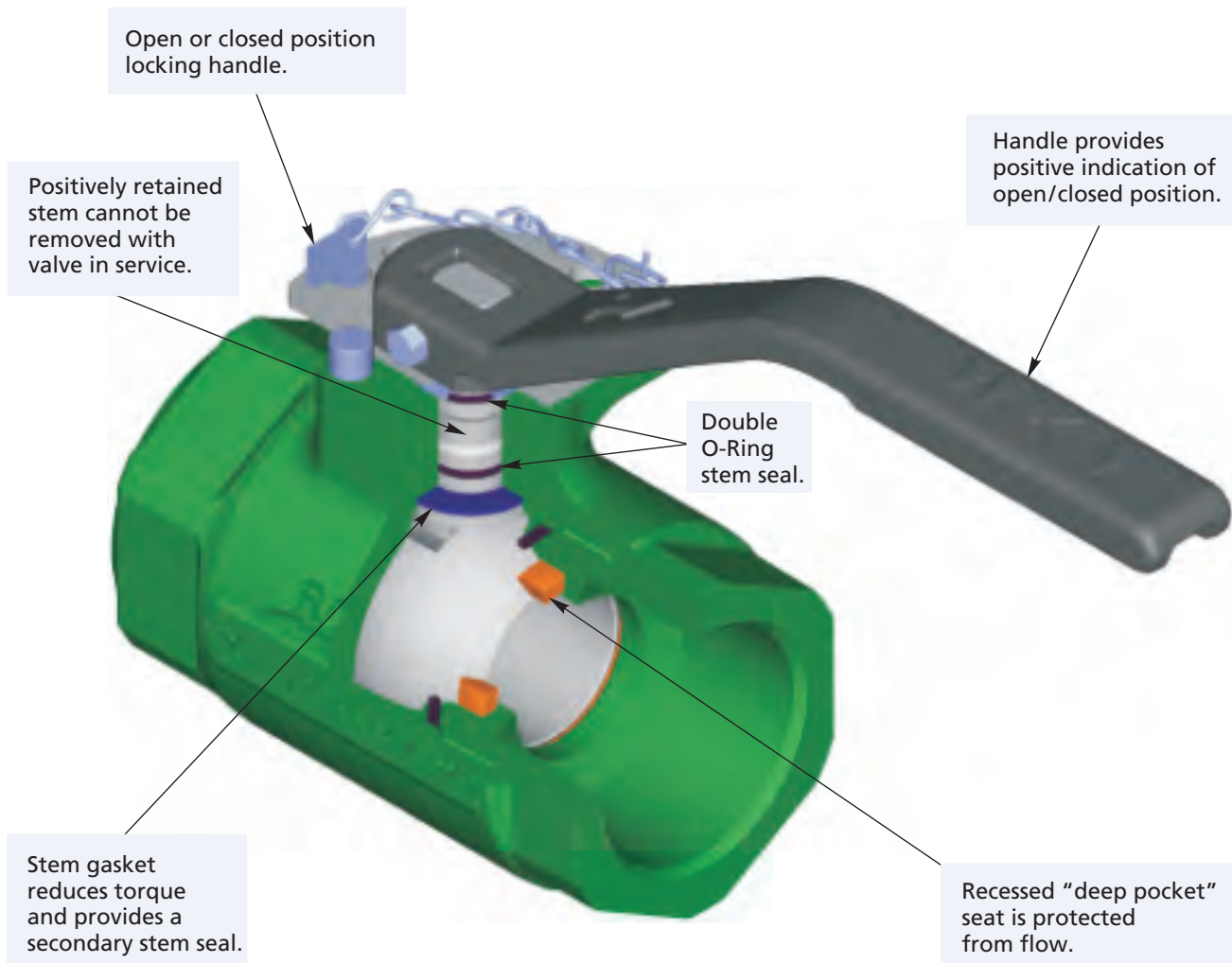

WKM DYNASEAL 210 FEATURES AND BENEFITS

LOCKING CAPABILITY IS STANDARD

- The valve can be locked in the open or closed position.

POSITIVELY RETAINED STEM

- The stem is positively retained. It is designed to prevent stem blowout while the valve is in service.

COLOR CODED WORKING PRESSURES

The lock plates are color coded so pressure ratings are quickly identified

- 750/1,000 psi green.
- 1,500 psi blue.
- 2,000 psi red.

UNIDIRECTIONAL BALL (OPTION)

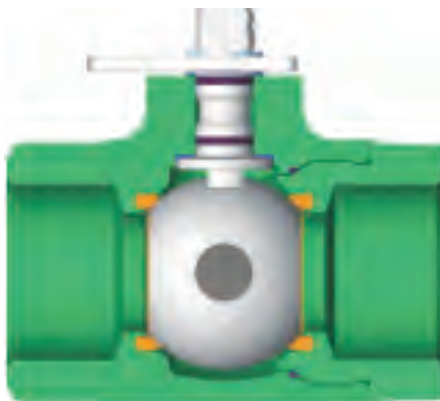

The WKM DynaSeal 210 unidirectional valve option provides relief to valves that might have water trapped in the body cavity and then be exposed to a temporary freeze. Since this option relies on a relief hole in the ball to relieve the excess pressure the valve is stamped with a directional flow arrow to be sure the side of the ball with the hole is installed upstream.

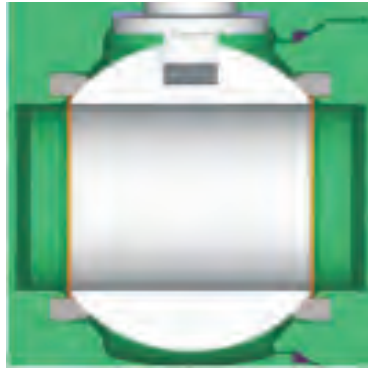

FIRE TESTED DESIGN

The WKM DynaSeal 210 ball valves are qualified under API Standard 607. The deep pocketed seat, locked in stem and body/tailpiece designs give this valve excellent fire tested characteristics.



SUPERIOR STEM JOURNAL DESIGN PREVENTS STEM SEIZURE

The stem is designed with two internal O-ring grooves located on either side of a shallow grease groove. The top O-ring is a weather seal while the bottom one seals the stem bore against the line media. The stem gasket provides a backup seal.

The shallow groove between the O-rings provides three benefits:

- prevents stem seizure
- reduces torque
- provides a space for lubricating grease applied at the factory during assembly.

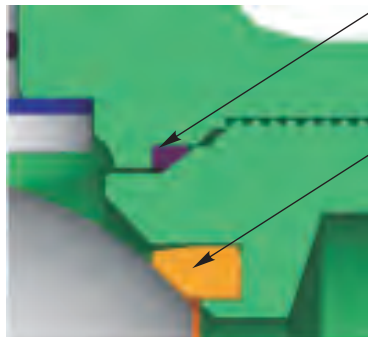

TFE BODY SEAL

A TFE body seal is positioned between the line bore and tailpiece threads isolating the threads from the line media.

DEEP RECESSED SEATS

The seat is recessed into a deep machined pocket, which serves to surround and protect the seat on all sides. This design eliminates cold flow into the valve conduit where it can be damaged by the action of the ball or the flow medium. The result is extremely long service life.



SEAL PIN DEVICE PROVIDED AS STANDARD ON 750 AND 1000 psi, 2 in., 3 in. AND 4 in. (50 mm, 80 mm AND 100 mm) REDUCED PORT VALVES.

A secondary seal pin device for applying tamper detection is provided on these valves. These valves are a popular choice for production tank batteries where tamper detection is often required.

WKM DYNASEAL 210
1 in. (25 mm) FULL PORT THROUGH
4 in. x 3 in. (100 mm x 80 mm) REDUCED PORT

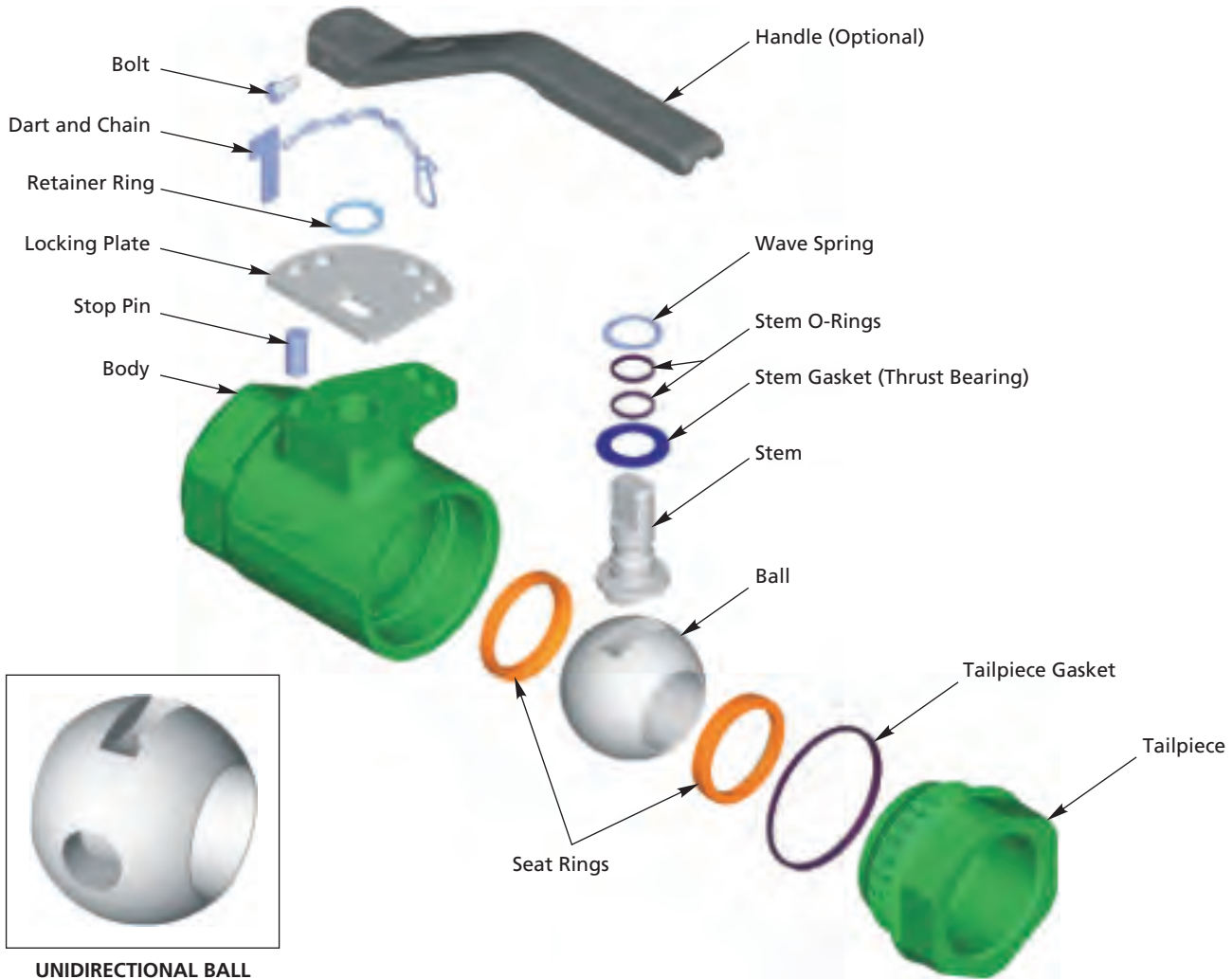

UNIDIRECTIONAL BALL

STANDARDS AND SPECIFICATIONS

WKM DynaSeal 210 ball valves conform to the following design and testing standards:

STANDARD MATERIALS

- API line pipe threads
- Body: Ductile Iron
- Ball and Stem: Carbon Steel or Stainless Steel
- Seat and Seals: Acetal Plastic/Buna-N

OPTIONAL MATERIALS

- Ball and Stem: Stainless Steel
- Seat and Seals: TFE/FKM

COMPLIANCES

- ASME/ANSI B16.5
- MSS-SP-6, 25, 55, 72 and 61
- NACE MR0175 (Rev. 2002)
- API 607 (Fire Test Specification)

WORKING PRESSURE

SIZE		psig			
in.	(mm)	750	1000	1500	2000
1	(25)	FP		•	•
2 x 1 1/2	(50 x 40)	RP	•	•	•
2	(50)	FP	•	•	•
2 1/2 x 2	(65 x 50)	RP		•	•
3 x 2	(80 x 50)	RP	•	•	•
3	(80)	FP	•	•	•
4 x 3	(100 x 80)	RP	•	•	•

WKM DYNASEAL 210
1 in. (25 mm) FULL PORT THROUGH
4 in. x 3 in. (100 mm x 80 mm) REDUCED PORT
750, 1000, 1500 and 2000 psig WORKING PRESSURE

STANDARD MATERIALS

Qty.	DESCRIPTION	MATERIAL
1	Body	ASTM A395 Ductile Iron
1	Tailpiece	ASTM A395 Ductile Iron
1	Ball	Carbon Steel Chrome Plated 316 SS
1	Stem	AISI 1213/1215, Steel, Zinc Plated 316 SS (Type 630 on 2 in. x 1 1/2 in. (50 mm x 40 mm))
2	Seat Ring	Acetal Plastic (43) Filled TFE (42)
1	Tailpiece Gasket	PTFE
2	Stem O-Ring	Buna-N FKM
1	Stem Gasket (Thrust Bearing)	Filled TFE
1	Locking Plate	Steel 1018/26
1	Locking Plate Retaining Ring	Spring Steel
1	Wave Spring	Spring Steel
1	Stop Pin	Spring Steel
1	Handle	ASTM A395 Ductile Iron
1	Handle Retainer	Nut on 1 in. (25 mm) Retainer Ring on 2 in. x 1 1/2 in. (50 mm x 40 mm) Bolt on 2 in. (50 mm) FP through 4 in. x 3 in. (100mm x 80 mm)
1	Seal Pin/Dart	Brass or Aluminum

Note: For H₂S service use Trim Code -X13220X. Meets NACE MR0175 (Rev. 2002) (see "How To Order" page 1).

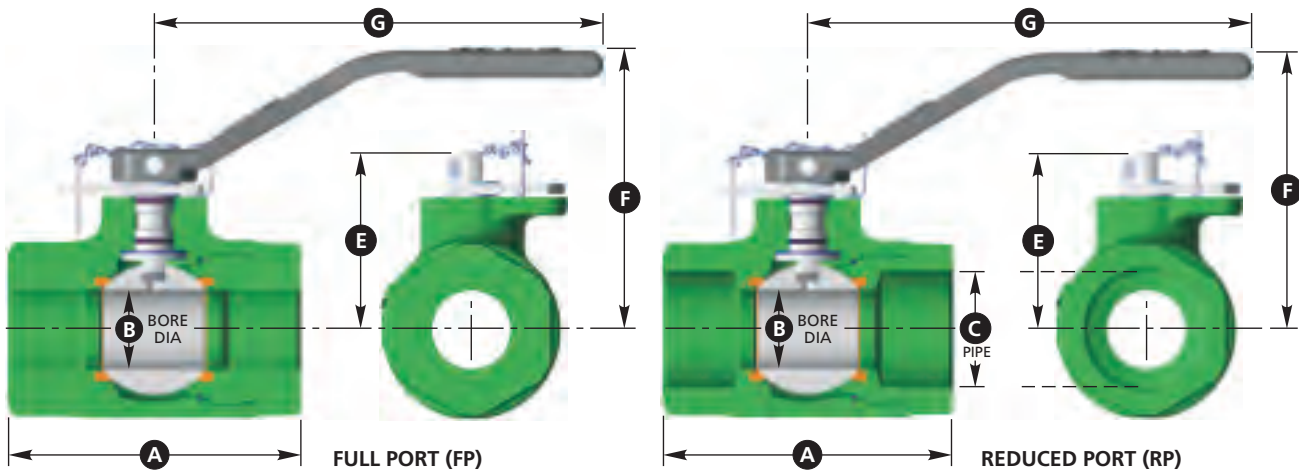
WKM DYNASEAL 210 DIMENSIONS AND WEIGHTS

DIMENSIONAL DATA

SIZE in.	DIMENSION A		B	APPROXIMATE DIMENSIONS in inches			
	THREADED	GROOVED		C	E	F	G
1 FP	4.00	-	1.00	1.00	2.77	4.0	7.1
2 RP	5.55	5.25	1.50	2.00	3.56	4.9	7.1
2 FP	6.00	-	2.00	2.00	4.50	4.9	15.0
2 1/2 RP	7.00	-	2.00	2.50	4.50	4.9	15.0
3 RP	7.25	7.25	2.00	3.00	4.50	4.9	15.0
3 FP	8.75	-	3.00	3.00	5.66	6.0	15.0
4 RP	8.75	8.88	3.00	4.00	5.66	6.0	15.0
SIZE mm	APPROXIMATE DIMENSIONS in millimeters						
25 FP	102	-	25	25	70	102	180
50 RP	141	133	38	50	90	124	180
50 FP	152	-	51	50	114	124	381
65 RP	178	-	51	65	114	124	381
80 RP	184	184	51	80	114	124	381
80 FP	222	-	76	80	144	152	381
100 RP	222	226	76	100	144	152	381

WEIGHTS FULL PORT

OPERATION	VALVE SIZE in. WEIGHT lb.		
	1 x 1	2 x 2	3 x 3
Without Handle lb.	4.0	14.4	42.8
With Handle lb.	4.5	17.6	46.0
OPERATION	VALVE SIZE mm WEIGHT kg		
	25 x 25	50 x 50	80 x 80
Without Handle kg	1.8	6.5	19.4
With Handle kg	2.0	8.0	20.9

WEIGHTS REDUCED PORT

OPERATION	VALVE SIZE in. WEIGHT lb.			
	2 x 1 1/2	2 1/2 x 2	3 x 2	4 x 3
Without Handle lb.	9.4	15.5	16.6	35.5
With Handle lb.	9.9	18.0	19.8	38.7
OPERATION	VALVE SIZE mm WEIGHT kg			
	50 x 40	65 x 50	80 x 50	100 x 80
Without Handle kg	4.3	7.0	7.5	16.1
With Handle kg	4.5	8.2	9.0	17.6

WKM DYNASEAL 310 HOW TO ORDER

2	R	B	1	3	6	C	S	4	3	S	2	W	R
Size inches	Port Reduced Port = R Full Port = F	Valve Type				Body Tailpiece Code	Seal Code	Ball & Stem Code	Actuator Code				

Material	Codes
Carbon Steel	CS
Controlled hardness carbon steel for H ₂ S service	CS2*
Same as CS2, but special for -50°F (-46°C) service	CS3*
316 stainless steel for wetted parts	S1
316 stainless steel with stainless steel external trim. Good for -50°F (-46°C).	S8*

* Meets NACE *MR0175 (Rev. 2002)

Materials	Code
Carbon Steel	CS
316 Stainless Steel	S1
Ni-Cu Alloy	ML
17-4PH	S2*

* NACE 4 in. (100 mm) RP and smaller.
17-4 PH Stem, 316 Stainless Steel Ball.

Seal Number	Seal Material	Tailpiece Gasket Material
01	PTFE	PTFE
42	Filled PTFE	PTFE
43	Homopolymer Acetal Plastic	PTFE
07	FKM	PTFE
18	HPT-2	Filled PTFE
23	Celcon	PTFE
28	Filled PTFE	Filled PTFE
48	Homopolymer Acetal Plastic	Filled PTFE
60	Stellite	Filled PTFE
92H	316 SS with Chrome Carbide & Filled PTFE	Filled PTFE

Actuator Code	
Wrench*	WR
Oval Handwheel	OH
Worm Gear	WG
Bare Stem	BS
Less Gear	LG
Less Wrench	LW

* Wrenches are part of the valve assembly on 4R bore and smaller valves. In 4 in. F through 8 x 6 in. (100 mm F through 200 x 150 mm) they are sold separately.

310 2-PIECE VALVE TYPES

SIZE in. (mm)	150 RF LP* SP*	300 RF LP* SP*	300 BW Butt Weld	600 RF	600 RJ
**1/2 (15) FP	B112 -	B130 -	-	-	-
**3/4 (20) RP	B102 -	B122 -	-	-	-
** 1 (25) RP	B102 -	B122 -	-	-	-
1 (25) FP	B110 -	B128 -	-	B182	B172
1 1/2 (40) FP	B110 -	B128 -	-	B182	B172
2 (50) RP	B100 -	B120 -	-	B114	B170
2 (50) FP	B110 -	B128 -	-	B182	B172
3 x 2 (80 x 50) RP	B100 -	B120 -	-	B114	B170
3 (80) FP	B110 -	B128 -	-	B182	B172
4 (100) RP	B100 -	B120 -	-	B114	B170
4 (100) FP	B110 -	B128 -	B150	B182***	B172***
6 (150) RP	- B102	B120 -	-	B114***	B170***
6 (150) FP	B110 B113	B128 -	B150	B182***	B172***
8 (200) RP	B100 B102	- B122	-	B114***	B170***
8 (200) FP	B110 -	B128 B134	B150	-	-
10 (300) RP	B100 -	B120 -	-	-	-
10 (300) FP	B110 -	B128 B134	B150	-	-
12 (300) RP	B100 -	B120 -	-	-	-
12 (300) FP	B110 -	B128 -	B150	-	-
14 (350) RP	B100 -	B120 -	-	-	-

* LP is Long Pattern, SP is Short Pattern.

** Unibody style valve.

*** The 4 in. (100 mm) and larger sizes are available in trim CS2-43-S2-WGA (Worm Gear Operated) only.

310 2-PIECE VALVE TYPES

SIZE in. (mm)	Female Thread	Male x Female
1/4 (8) FP	B138	-
3/8 (20) FP	B138	-
1/2 (15) RP	B136	B136 (M x F)**
1/2 (15) FP	B138	-
3/4 (20) FP	B138	B138 (M x F)**
1 (25) RP	B136	B136 (M x F)**
1 (25) FP	B138	-
1 1/2 (40) FP	B138	-
2 (50) RP	B136	-
2 (50) FP	B138	-
3 (80) FP	B138	-
4 (100) RP	B136	-

** Available in Body Tailpiece Code S8 Only.

Note: Threaded end valves have NPT internal pipe thread in full conformance with ASME/ANSI B2.1 and Federal Thread Handbook H-28.

310 3-PIECE VALVE TYPES

SIZE in. (mm)	SOCKET WELD
1/4 (8) FP	B103
3/8 (10) FP	-
1/2 (15) RP	B106
3/4 (20) FP	B103
1 (25) RP	B106
1 1/2 (40) FP	B103
2 (50) RP	B106

TRIM GUIDELINES FOR ALL WKM DYNASEAL 310 VALVES

This chart is an abbreviated guide to the chemical resistance and pressure/temperature limitations of the seal materials used in the WKM DynaSeal 310 valve.

Consult your DynaSeal distributor or the WKM factory regarding questions about trim selections.

SEAL CODE	SEAT MATERIAL	TAILPIECE GASKET	SERVICE APPLICATION
01	TFE	TFE	Seat and Tailpiece gaskets are of virgin TFE. Use where lading contamination from glass or other fillers is not desirable, such as in food service. Recommended for low temperature service to -50°F (-46°C). Also recommended for vacuum service.
42	Filled TFE	TFE	Seat material is TFE filled with inert materials for use at elevated temperatures and pressures. Same chemical resistance as Virgin TFE except slightly affected by hot concentrated alkaline solutions. Some chlorinated compounds can cause swelling. Also recommended for low temperature service -50°F (-46°C). Good for vacuum service.
43	Homopolymer Acetal Plastic	TFE	For general use at high pressures to temperature of 220°F (104°C).
48	Homopolymer Acetal Plastic	Filled TFE	For general use at high pressures to temperature of 220°F (104°C). Used on socket weld end valves 3 in. (80 mm) bore size and smaller.
07	*FKM/SS	TFE	High and low pressure block and bleed. General use for low pressure and abrasion resistance. Not suitable for steam. Good for vacuum service. Available in bore sizes to 3 in. (80 mm).
18	HPT-2	Filled TFE	HPT-2 is a special TFE formulation for use at temperatures above trim 42 capability. Best suited for constant temperature or constant pressure applications. Proven service in steam, hot oil, heat transfer fluids, hot resins, boiler feed water. Same chemical resistance as TFE. Slightly affected by hot, concentrated alkaline solutions. Some fluorinated compounds cause swelling.
23	Celcon	TFE	For use in high pressure applications. Temperature limited to 225°F (107°C) (1/4 in. to 3/4 in. (8 mm to 20 mm) bores only).
28	Filled TFE	Filled TFE	Same as 42 except tailpiece gasket is filled TFE. Used on weld end valves 4 in. (100 mm) and larger.
60	Stellite	Filled TFE	Special Stellite seats for use when hard faced metal seats are required for industrial applications including the pulp and paper industry. Leakage Class V.
92H	316 SS with Chrome Carbide and Filled TFE	Filled TFE	For temperatures to 600°F (316°C). For slurries, abrasives, steam, hot water. Leakage Class V.

Note 1: Trim 07 and 18 should be tested for each application by actual use.

Note 2: All seal codes with the exception of 07, 60 and 92H have been fire tested (and qualified) to API 607 4th Edition requirements.

* Trim sizes smaller than 1 1/2 in. (40 mm) in trim 07 are 100% elastomeric. Sizes 1 1/2 in. (40 mm) and larger are elastomeric with a metal insert.

WKM DYNASEAL 310 FEATURES AND BENEFITS

A premium quality floating ball valve that has proven itself in a wide variety of oilfield, chemical, petrochemical and hydrocarbon processing applications.

THREADED VALVE ASSEMBLY
 1/4 in. (8 mm) FULL PORT THROUGH
 4 in. x 3 in. (100 mm x 80 mm) REDUCED PORT.

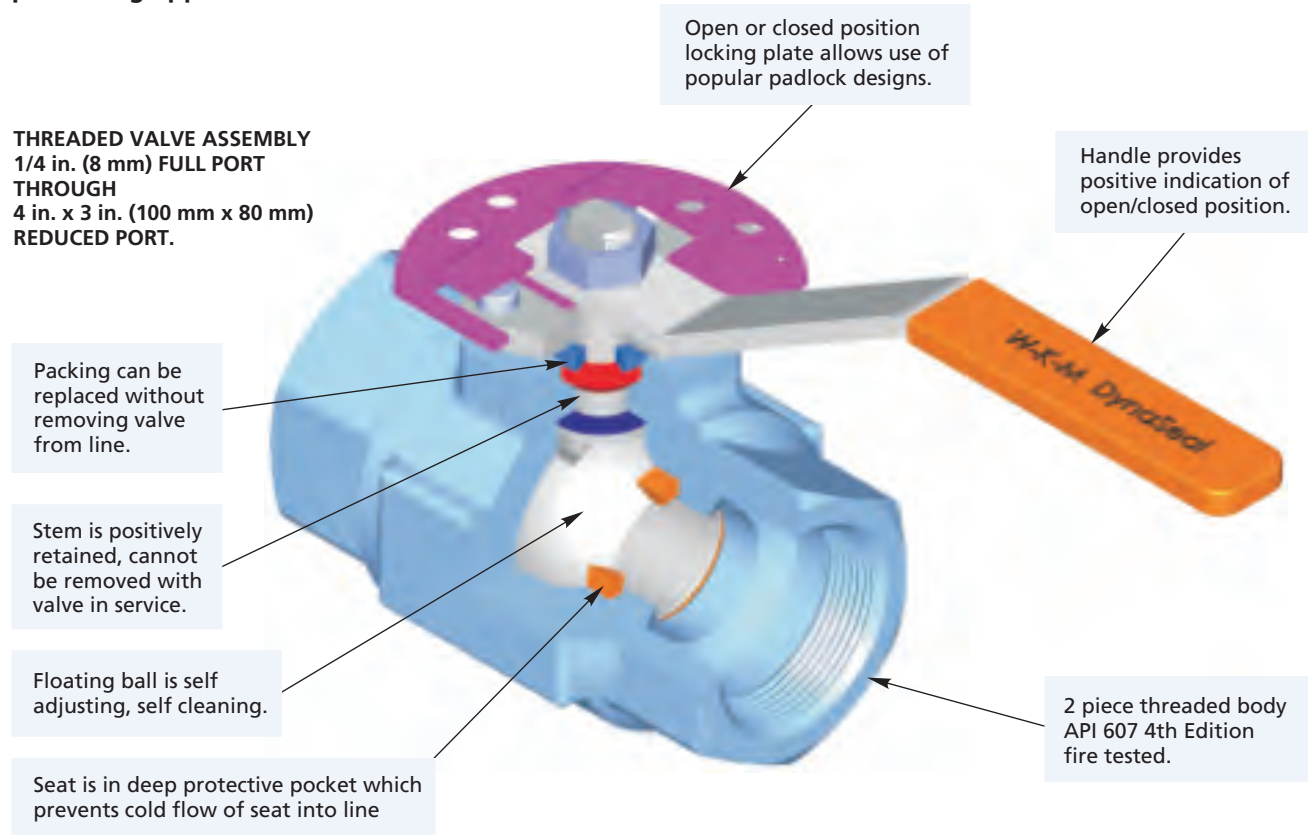

FLANGED VALVE ASSEMBLY
 1 in. (25 mm) FULL PORT THROUGH
 4 in. x 3 in. (100 mm x 80 mm) REDUCED PORT.

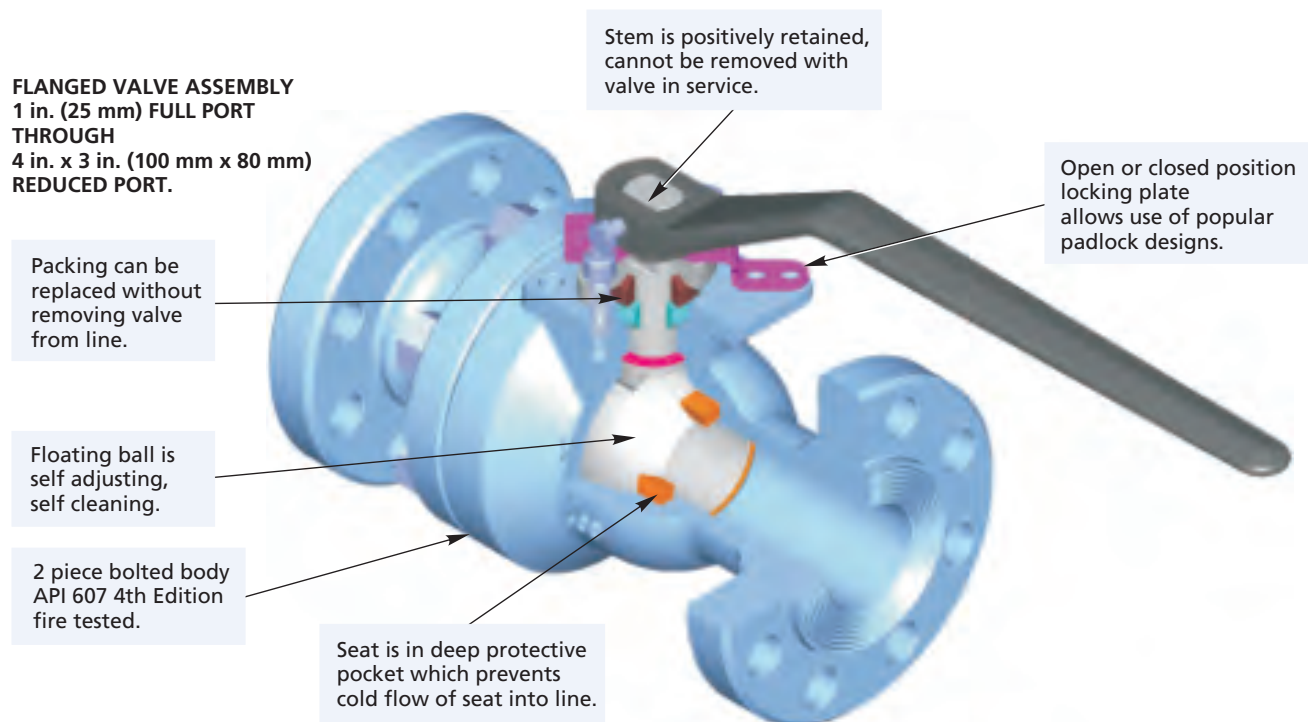

WKM DYNASEAL 310

WKM DynaSeal 310 floating ball valves satisfy a wide range of applications. Available in a variety of standard and optional materials, in sizes from 1/4 in. (8 mm) to 4 in. x 3 in. (100 mm x 80 mm) and working pressures to 5000 psi. Engineered for heavy duty, maintenance free performance, the DynaSeal 310 valve is preferred for use in critical applications.

SOUR OIL AND GAS SERVICE

WKM DynaSeal ball valves are suited to applications within gathering lines, manifolds and field processing units in sour oil and gas fields. They can be trimmed to conform with NACE MR0175 (Rev. 2002).

FEATURES AND BENEFITS

DEEP RECESSED SEATS

The WKM DynaSeal 310 seat is protected in a machined recess or deep pocket that surrounds and protects the seat. This design eliminates cold flow into the valve conduit and avoids potential seat damage from ball movement or flow media.

TRIM 42 SEATS

Seats are manufactured of filled TFE and rated to 1500 psi MOP. With working temperatures to 500°F (260°C) and low torque operation these seats satisfy even the most difficult of processing requirements.

TRIM 43 SEATS

Seats are manufactured of Acetal Plastic and rated to 3000 psi MOP and working temperatures to 220°F (104°C). These seats are designed to handle the most demanding applications. These seats are designed to flex under pressure and provide a consistent range of low torque operations. They provide a full face seal against the ball and multiple seals against the top and back of the pocket to provide a positive seal.

ADJUSTABLE, REPLACEABLE PACKING

The in line valve stem packing consists of PTFE impregnated graphite with an impervious metal barrier and a secondary tapered metal back up. The packing is field adjustable and never requires lubrication. The packing and the stainless steel cap can be replaced without removing the valve from the line.

POSITIVELY RETAINED STEM

The stem is positively retained with a shoulder. It cannot be removed with the valve in service.



310 Unibody
1/2 in., 3/4 in. x 1/2 & 1 in. x 3/4 in.
(15 mm, 20 mm x 15 mm and
25 mm x 20 mm) Class 150 & 300 Flanged.



Socket Weld End
310 Ball Valve

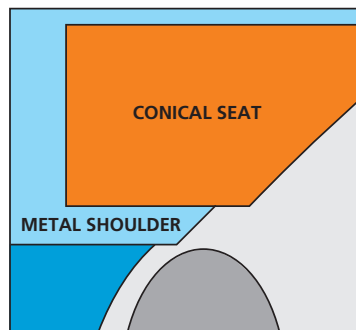

TRIM 42 SEAT

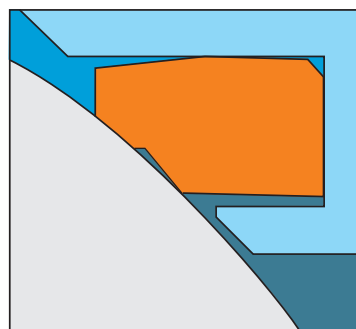

TRIM 43 SEAT



ADJUSTABLE PACKING

FLOATING BALL DESIGN DELIVERS TIGHT SEAL

The ground and polished ball is free to float and mates perfectly with the conical seats for a positive, leakproof seal. Self cleaning and self adjusting, the ball is also pressure activated - the higher the line pressure, the tighter the seal.

FIRE-TESTED FOR SAFETY

All WKM DynaSeal 310 valves are qualified under API standard 607 4th Edition. The pocketed seat and locked in stem design contributes to its excellent fire tested characteristics. Should the soft seats be destroyed by fire, the ball floats down stream, providing a tight metal to metal seal against the lip of the seat pocket. If the tailpiece seals are destroyed, the metal to metal tailpiece to body connection retards external leakage.

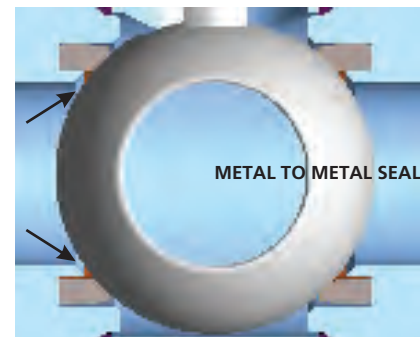
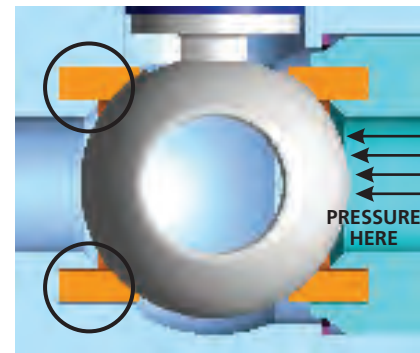

INDICATOR HANDLE

The design of the handle permits installation on the stem in the correct position only, in alignment with the ball port. When the handle is aligned with the pipe, the valve is open. When the handle is perpendicular to the pipe, the valve is closed.

LOCKING DEVICES

Locking devices are standard on all 4 in. x 3 in. (100 mm x 80 mm) and smaller manually operated valves and permit locking in either the open or closed positions.

WKM DYNASEAL 310

SOCKET WELD ENDS

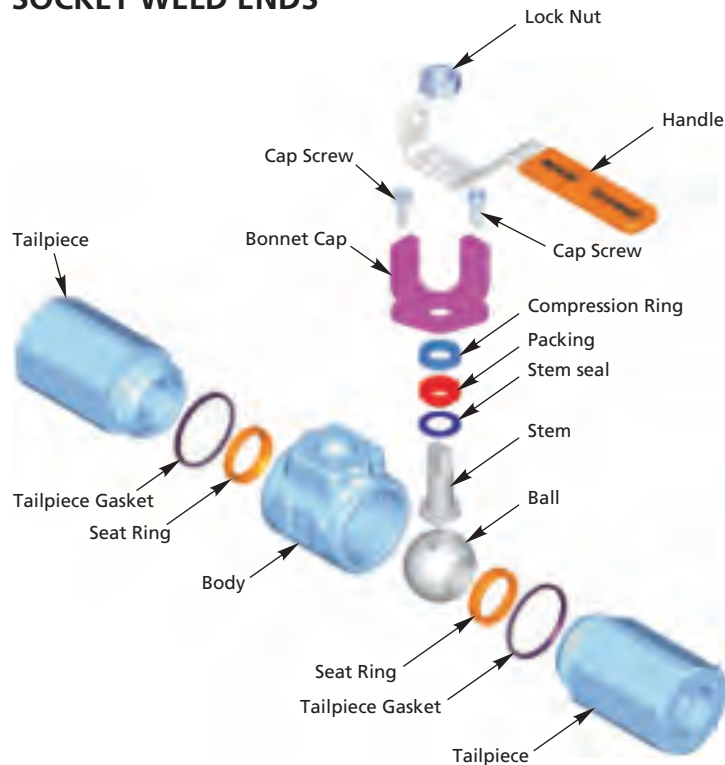

FLANGED ENDS - UNIBODY DESIGN

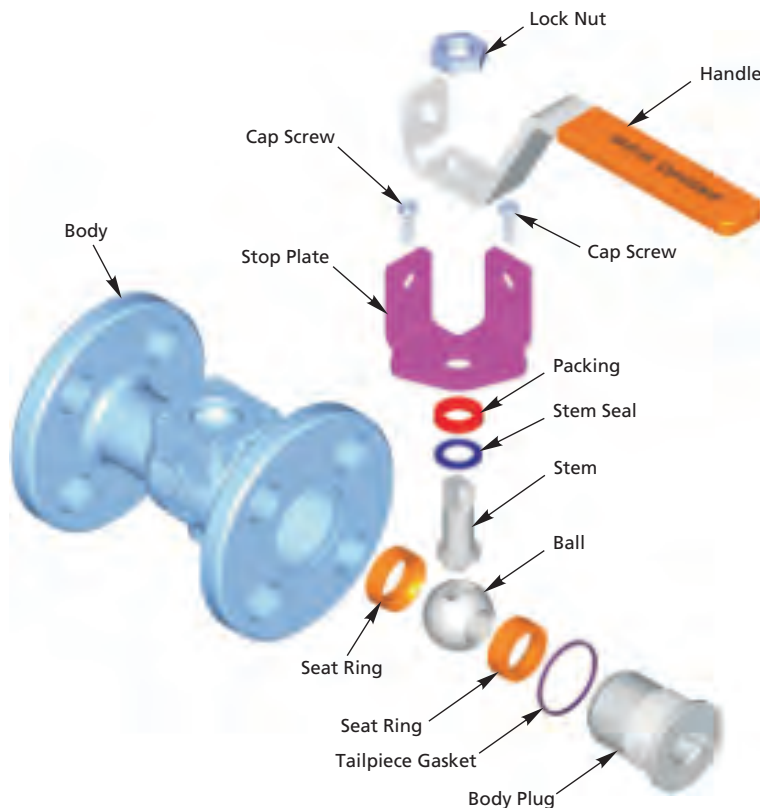

STANDARDS AND SPECIFICATIONS

Sizes:

- 1/4 in. (8 mm) Full Port
- 1/2 in. (15 mm) Reduced Port
- 3/4 in. (20 mm) Full Port
- 1 in. (25 mm) Reduced Port
- 1 1/2 in. (40 mm) Full Port
- 2 in. (50 mm) Reduced Port.

WORKING PRESSURE

- 3000 psi with Trim "48"

OPERATING TEMPERATURES

- From -20°F to 220°F (-29°C to 104°C).

END CONNECTIONS

- Socket Weld Ends.

STANDARD MATERIAL

Body:

- Carbon Steel and Carbon Steel NACE MR0175 (Rev. 2002).

Ball/Stem:

- Carbon Steel or Stainless Steel.

Seats:

- Trim "48" (Acetal Plastic Seats).

INDUSTRY STANDARDS COMPLIANCE

- ASME/ANSI B16.34
- MSS-SP-25, 55, 72
- API 607 4th Edition (Fire Test).

STANDARDS AND SPECIFICATIONS

Sizes:

- 1/2 in. (15 mm) Full Port
- 3/4 in. x 1/2 in. (20 mm x 15 mm) Reduced Port
- 1 in. x 3/4 in. (25 mm x 20 mm) Reduced Port

PRESSURE CLASS

- ASME/ANSI 150 & 300

STANDARD END CONNECTIONS

- Flanged, Raised Face.

STANDARD MATERIAL

Body:

- Carbon Steel, CF8M SS.

Ball/Stem:

- Carbon Steel, 316 SS/Type 630

Seats:

- Select from page 8.

OPTIONAL MATERIALS

- Bodies, Stems & Balls can be offered in different alloys - Consult Factory.

Seat Materials:

- High Temp TFE, FKM, Stellite, Chromium Carbide Coated, Acetal Plastic.

INDUSTRY STANDARDS COMPLIANCE

- ASME/ANSI B16.34, B16.5.
- MSS-SP-6, 25, 55, 72.
- API 607 4th Edition (Fire Test).

WKM DYNASEALS 310

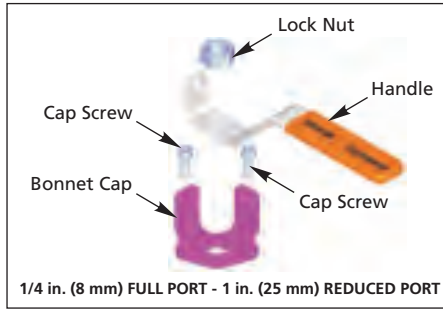

THREADED ENDS

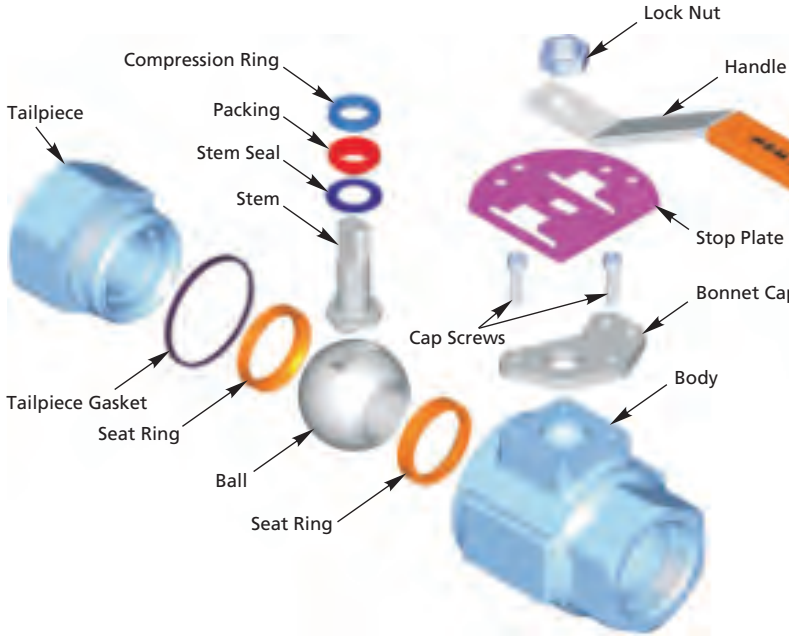

FLANGED ENDS

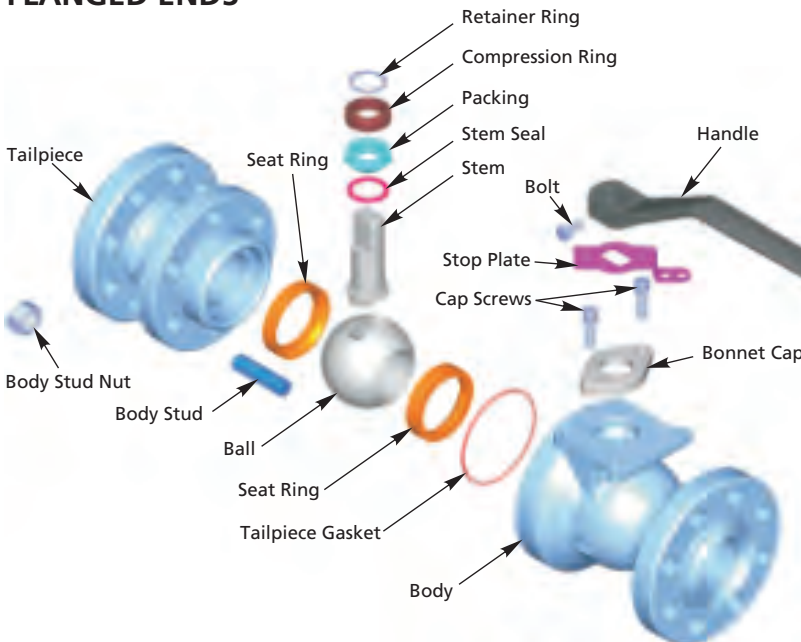

THREADED CONNECTIONS

FULL PORT SIZE		REDUCED PORT SIZE	
in.	(mm)	in.	(mm)
1/4	(8)	1/2	(15)
3/8	(10)	1	(25)
1/2	(15)	2	(50)
3/4	(20)	3	(80)
1	(25)	4	(100)
1 1/2	(40)		
2	(50)		
3	(80)		

STANDARDS AND SPECIFICATIONS

- To 5000 psi in small sizes
- Trim 43 pressure range to 3000 psi in 1/4 in. (8 mm) to 3 in. x 2 in. (80 mm x 50 mm) Threaded End Valves

OPERATING TEMPERATURES

- From -50°F to 600°F (-46°C to 316°C)

STANDARD MATERIAL

Body:

- Carbon Steel and Stainless Steel

Ball/Stem:

- Carbon Steel, Stainless Steel and Monel

Seat/Seal Trims:

- TFE, Filled TFE, Acetal Plastic, HPT-2, 316 Stainless Steel with Chromium Carbide and FKM

INDUSTRY COMPLIANCE:

- ASME/ANSI B16.5, B16.34
- MSS-SP-6, 25, 55, 72
- API 607 4th Edition (Fire Test Specification)

FLANGED CONNECTIONS ASME/ANSI PRESSURE CLASS

SIZE	CLASS		
	in.	(mm)	150 300 600
1	(25)	FP	• • •
1 1/2	(40)	FP	• • •
2 x 1 1/2	(50 x 40)	RP	• • •
2	(50)	FP	• • •
3 x 2	(80 x 50)	RP	• • •
3	(80)	FP	• • •
4 x 3	(100 x 80)	RP	• • •

WKM DYNASEAL 310

1/4 in. (8 mm) FULL PORT THROUGH 4 in. (100 mm) REDUCED PORT

MATERIALS LIST - THREADED AND FLANGED ENDS

BODY/TAILPIECE MATERIAL CODE

PART	CS	CS2*	CS3*	S8*
Body	ASTM A105/A216 Gr. WCC	ASTM A105/A216 Gr. WCC	ASTM A350 LF2	316 SS/A351 CF8M
Studs	A193 Gr. B7	A193 Gr. B7M	A320 Gr. L7M	A193 Gr. B8
Nuts	A194 Gr. 2H	A194 Gr. 2HM	A194 Gr. 7ML	A194 Gr. 8
Body Plug**	Carbon Steel	Carbon Steel	Carbon Steel	Stainless Steel
Tailpiece	ASTM A105/A216 Gr. WCC***	ASTM A105/A216 Gr. WCC	ASTM A350 LF2	316 SS/A351 CF8M
Nameplate	Stainless Steel	Stainless Steel	Stainless Steel	Stainless Steel
Bonnet Cap	Carbon Steel	Carbon Steel	Carbon Steel	Stainless Steel
Packing Adjusting Screws	Alloy Steel Plated	18-8 SS	18-8 SS	18-8 SS

* CS2/CS3/S8 to be used for H₂S service with S2 internal trim only. Meets NACE MR0175 (Rev. 2002).

** When body drain is specified.

*** AISI 1018 Seat Retainers are used in 1/2 in., 3/4 in. and 1 x 3/4 in. (15 mm, 20 mm and 25 mm x 20 mm) Class 150 and 300 unibody valves.

SEAT SEAL MATERIAL CODE

PART	01	23**	42	43	48***	07	18	60*	92H*
Seat	TFE	Celcon	Filled TFE	Acetal Plastic	Acetal Plastic	FKM	Special Filled TFE	Stellite	316 SS Chromium Carbide Coated
Tailpiece Gasket	TFE	TFE	TFE	TFE	Filled TFE	TFE	Filled TFE	Filled TFE	Filled TFE
Stem Seal	TFE					Filled TFE			
Packing					Graphite/TFE w/SS Cap				

* 1 inch (25 mm) Full Port and larger.

** 1 inch (25 mm) Reduced Port and smaller.

*** Socket Weld End valves only

BALL/STEM MATERIAL CODE

PART	CS	S1	S2*	ML
Ball	AISI 1213 CS Chrome Plate	316 SS	316SS	B164 Class B Ni-Cu Alloy
Stem	AISI 1213 Zinc Plate	316 SS	Type 630	B 164 Class B Ni-Cu Alloy
Compression Ring	304 SS	304 SS	304 SS	304 SS

Note: *S2 Trim (Type 630 Stem & 316 SS Ball) is required for H₂S service per NACE MR0175 (Rev. 2002) to be used with Body/Tailpiece codes

ACTUATOR CODE

PART (BODY)	CS	CS2	CS3	S1	S8
Lock Nut*	Alloy Steel	Alloy Steel	Alloy Steel	Alloy Steel	Stainless Steel
Handle*	CS Zinc Plated	CS Zinc Plated	CS Zinc Plated	CS Zinc Plated	Stainless Steel
Handle Grip*	Vinyl	Vinyl	Vinyl	Vinyl	Vinyl
Wrench Handle**	Ductile Iron	Ductile Iron	Ductile Iron	Ductile Iron	Ductile Iron
Wrench Head Bolt & Nut**	Alloy Steel	Alloy Steel	Alloy Steel	Alloy Steel	Alloy Steel
Stop Plate	Stainless Steel	Stainless Steel	Stainless Steel	Stainless Steel	Stainless Steel

* 2 inch (50 mm) Reduced Port and smaller.

** 2 inch (50 mm) Full Port and larger.

WKM DYNASEAL 310

1/4 in. (8 mm) FULL PORT THROUGH 4 in. (100 mm) REDUCED PORT FLANGED, THREADED AND SOCKET WELD

B136/B138 Threaded

B100/B110 Class150 Raised Face Flanges

B170/B172 Class 600 Ring Joint Flanges

B106/B103 Socket Weld

B120/B128 Class 300 Raised Face Flanges

B102/B112 Class150 Raised Face Flanges

B114/B182 Class 600 Raised Face Flanges

B122/B130 Class 300 Raised Face Flanges

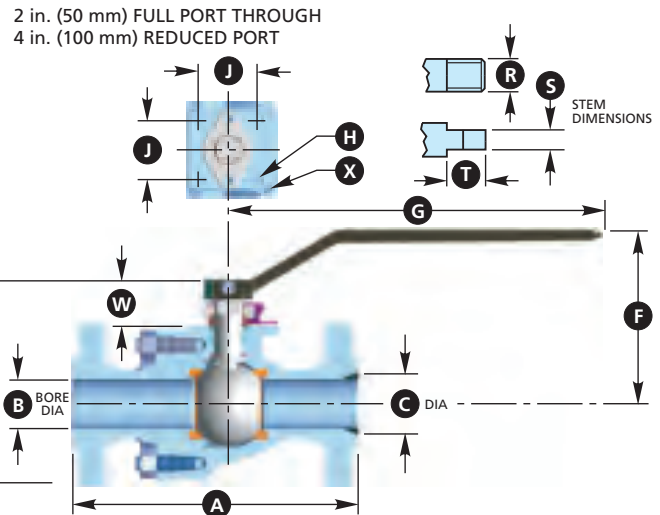
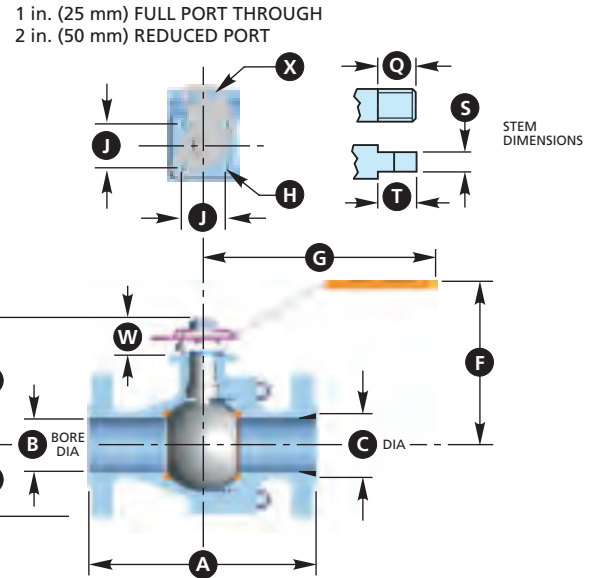
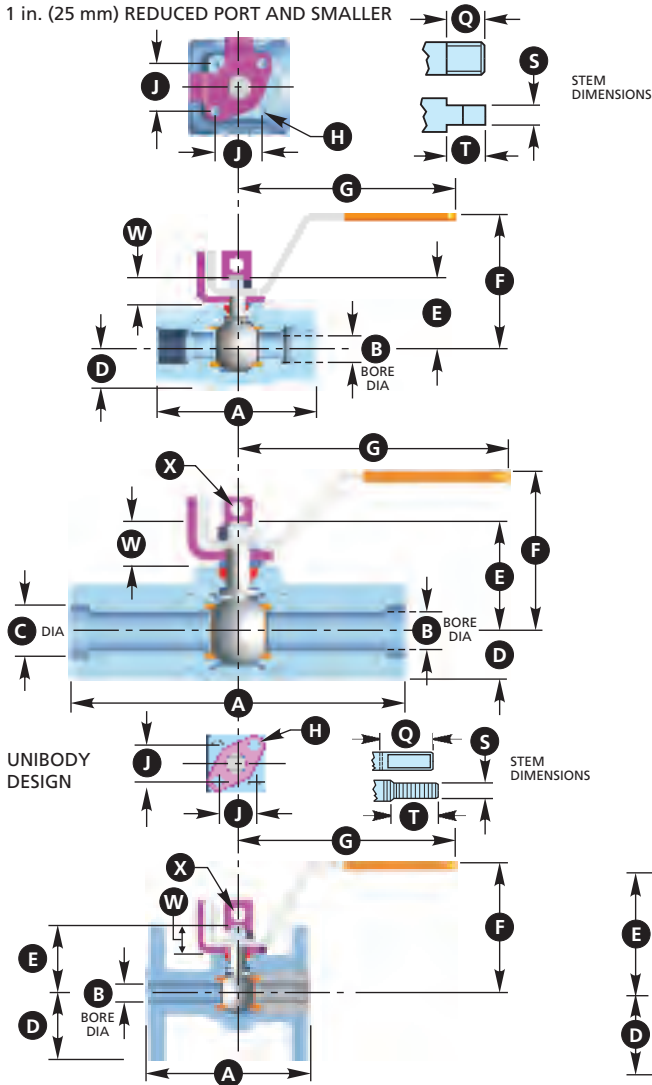

UNIBODY VALVES - FLANGED ENDS

SIZE in.	A				Approximate Dimensions in inches												
	150 Flg B102	300 Flg B122	150 Flg B112	300 Flg B130	B	D	E	F	G	H*	J	Q*	S	T	W	X	
1/2 FP	-	-	4.25	-	0.50	1.75	1.8	3.5	5.8	10-24 .38 DP	1.0	7/16-20	0.246	0.41	0.72	0.38	
	-	-	-	5.50	0.50	1.88	1.8	3.5	5.8	10-24 .38 DP	1.0	7/16-20	0.246	0.41	0.72	0.38	
3/4 RP	4.62	-	-	-	0.50	1.94	1.8	3.5	5.8	10-24 .31 DP	1.0	7/16-20	0.246	0.41	0.72	0.38	
	-	6.00	-	-	0.50	2.31	1.8	3.5	5.8	10-24 .31 DP	1.0	7/16-20	0.246	0.41	0.72	0.38	
1 RP	5.00	-	-	-	0.75	2.13	2.3	4.0	6.7	10-24 .25 DP	1.0	7/16-20	0.246	0.48	0.84	0.38	
	-	6.50	-	-	0.75	2.44	2.3	4.0	6.7	10-24 .25 DP	1.0	7/16-20	0.246	0.48	0.84	0.38	
SIZE mm																	
Approximate Dimensions in millimeters																	
15 FP	-	-	108	-	13	44	46	89	147	10-24 9.7 DP	25	7/16-20	6	10	18	10	
	-	-	-	140	13	48	46	89	147	10-24 9.7 DP	25	7/16-20	6	10	18	10	
20 RP	117	-	-	-	13	49	46	89	147	10-24 7.9 DP	25	7/16-20	6	10	18	10	
	-	152	-	-	13	49	46	89	147	10-24 7.9 DP	25	7/16-20	6	10	18	10	
25 RP	127	-	-	-	19	54	58	102	170	10-24 6.4 DP	25	7/16-20	6	12	21	10	
	-	165	-	-	19	54	58	102	170	10-24 6.4 DP	25	7/16-20	6	12	21	10	

* American National Thread in inches.

WKM DYNASEAL 310

1/4 in. (8 mm) FULL PORT THROUGH 4 in. (100 mm) REDUCED PORT FLANGED, THREADED AND SOCKET WELD DIMENSIONS

THREADED AND FLANGED ENDS

SIZE in.	A				B	C	D				E	F	G	H*	J	Q*	R	S	T	W	X	
	THD	150	300	600			600RJ	THD	150	300												600
1/4 FP	3.00	-	-	-	-	0.38	-	0.69	-	-	-	1.4	2.8	4.3	#8-32 .26 DP	0.88	5/16-24	-	0.18	0.25	0.55	0.38
3/8 FP	3.25	-	-	-	-	0.38	-	0.69	-	-	-	1.4	2.8	4.3	#8-32 .26 DP	0.88	5/16-24	-	0.18	0.25	0.55	0.38
1/2 RP	3.75	-	-	-	-	0.38	-	0.69	-	-	-	1.4	2.8	4.3	#8-32 .26 DP	0.88	5/16-24	-	0.18	0.25	0.55	0.38
1/2 FP	4.00	-	-	-	-	0.50	-	0.81	-	-	-	1.8	3.5	5.7	#10-24 .26 DP	1.00	7/16-20	-	0.26	0.34	0.72	0.38
3/4 FP	4.25	-	-	-	-	0.75	-	1.06	-	-	-	1.9	3.5	5.7	#10-24 .26 DP	1.00	7/16-20	-	0.26	0.34	0.72	0.38
1 RP	4.50	-	-	-	-	0.75	-	1.06	-	-	-	1.9	3.5	5.4	#10-24 .26 DP	1.00	7/16-20	-	0.26	0.34	0.72	0.38
1 FP	4.50	5.0	6.50	8.5	8.50	1.00	-	1.32	2.12	2.44	2.44	2.8	4.1	7.0	1/4-20 .39 DP	1.25	5/8-18	-	0.36	0.63	1.25	0.38
1 1/2 FP	5.25	6.5	7.50	9.5	9.50	1.50	-	1.81	2.50	3.06	3.06	3.7	5.0	9.5	5/16-18 .45 DP	1.50	3/4-16	-	0.45	0.81	1.50	0.38
2 RP	6.25	7.0	8.50	11.5	11.62	1.50	2.0	1.81	3.00	3.25	3.25	3.7	5.0	9.5	5/16-18 .45 DP	1.50	3/4-16	-	0.45	0.81	1.50	0.38
2 FP	6.25	7.0	8.50	11.5	11.62	2.00	-	2.38	3.00	3.25	3.25	5.0	5.4	15.0	1/2-13 .50 DP	2.44	-	1.12	0.69	1.37	1.88	0.38
3 x 2 RP	9.00	8.0	11.12	14.0	14.12	2.00	3.0	2.38	3.75	4.12	4.12	5.0	5.4	15.0	1/2-13 .50 DP	2.44	-	1.12	0.69	1.37	1.88	0.38
3 FP	10.00	8.0	11.12	14.0	14.12	3.44	-	3.28	3.75	4.12	4.12	6.4	7.1	15.0	1/2-13 .50 DP	3.00	-	1.12	0.74	1.75	2.31	0.38
4 RP	10.25	9.0	12.00	17.0	17.12	3.44	4.0	3.28	4.50	5.00	5.38	6.4	7.1	15.0	1/2-13 .50 DP	3.00	-	1.12	0.74	1.75	2.31	0.38

SIZE mm

6 FP	76	-	-	-	-	10	-	18	-	-	-	35	70	108	#8-32 6.6 DP	22	5/16-24	-	5	6	14	10
10 FP	83	-	-	-	-	10	-	18	-	-	-	35	70	108	#8-32 6.6 DP	22	5-16-24	-	5	6	14	10
15 RP	95	-	-	-	-	10	13	18	-	-	-	35	70	108	#8-32 6.6 DP	22	5/16-24	-	5	6	14	10
15 FP	102	-	-	-	-	13	-	20	-	-	-	45	89	145	#10-24 6.6 DP	25	7/16-20	-	7	9	18	10
20 FP	108	-	-	-	-	19	-	27	-	-	-	48	89	145	#10-24 6.6 DP	25	7/16-20	-	7	9	18	10
25 RP	114	-	-	-	-	19	25	27	-	-	-	48	89	137	#10-24 6.6 DP	25	7/16-20	-	7	9	18	10
25 FP	114	127	165	216	216	25	-	34	54	62	62	71	107	178	1/4-20 9.9 DP	32	5/8-18	-	9	16	31	10
40 FP	133	165	190	241	241	38	-	46	64	78	78	94	127	241	5/16-18 11.4 DP	38	3/4-16	-	11	21	38	10
50 RP	159	178	216	292	295	38	51	46	76	83	83	94	127	241	5/16-18 11.4 DP	38	3/4-16	-	11	21	38	10
50 FP	159	178	216	292	295	51	-	60	76	83	83	127	137	381	1/2-13 12.7 DP	62	-	28	18	35	48	10
80 x 50 RP	229	203	283	356	359	51	76	60	95	105	105	127	137	381	1/2-13 12.7 DP	62	-	28	18	35	48	10
80 FP	254	203	283	356	359	87	-	83	95	105	105	163	180	381	1/2-13 12.7 DP	76	-	28	19	44	59	10
100 RP	260	229	305	432	435	87	102	83	114	127	137	164	180	381	1/2-13 12.7 DP	76	-	28	19	44	59	10

SOCKET WELD END

SIZE in.		A	B	C	D	E	F	G	H	J	Q*	S	T	W	X
1/4 FP	B103	7.00	0.38	1.41	0.62	1.41	2.84	4.25	#8-32 .25 DP	0.88	5/16-24	0.18	0.25	0.56	0.38
1/2 RP	B106	7.88	0.38	1.41	0.62	1.41	2.84	4.25	#8-32 .25 DP	0.88	5/16-24	0.18	0.25	0.56	0.38
3/4 FP	B103	8.25	0.75	1.94	1.00	1.94	3.75	5.75	#10-24 .25 DP	1.00	7/16-20	0.26	0.34	0.75	0.38
1 RP	B106	8.25	0.75	1.94	1.00	1.94	3.75	5.75	#10-24 .25 DP	1.00	7/16-20	0.26	0.34	1.14	0.38
1 1/2 FP	B103	9.25	1.50	3.56	1.75	3.56	5.00	9.50	5/16-18 .44 DP	1.50	3/4-16	0.45	0.81	1.34	0.38
2 RP	B106	10.25	1.50	3.56	1.75	3.56	5.00	9.50	5/16-18 .44 DP	1.50	3/4-16	0.45	0.81	1.34	0.38

SIZE mm

8 FP	B103	177.80	9.65	35.81	15.75	35.81	72.14	107.95	#8-32 6.4 DP	22.35	5/16-24	4.57	6.35	14.22	9.65
15 RP	B106	200.15	9.65	35.81	15.75	35.81	72.14	107.95	#8-32 6.4 DP	22.35	5/16-24	4.57	6.35	14.22	9.65
20 FP	B103	209.55	19.05	49.28	25.40	49.28	95.25	146.05	#10-24 6.4 DP	25.40	7/16-20	6.60	8.64	19.05	9.65
25 RP	B106	209.55	19.05	49.28	25.40	49.28	95.25	146.05	#10-24 6.4 DP	25.40	7/16-20	6.60	8.64	28.96	9.65
40 FP	B103	234.95	38.10	90.42	44.45	90.42	127.00	241.30	5/16-18 11.2 DP	38.10	3/4-16	11.43	20.57	34.04	9.65
50 RP	B106	260.35	38.10	90.42	44.45	90.42	127.00	241.30	5/16-18 11.2 DP	38.10	3/4-16	11.43	20.57	34.04	9.65

* American National Thread in inches.

WKM DYNASEAL 310 FEATURES AND BENEFITS

Handle can be installed in correct position only in alignment with the ball port.
 Handle aligned with piping shows valve is open.
 Handle perpendicular shows valve is closed.
 4 in. (100 mm) and 6 in. (150 mm) bore only.

GEAR OPERATOR REQUIRED FOR 8 in. (200 mm) FULL PORT AND LARGER.

ASME/ANSI CLASS 150, 300 AND 300 BW
 4 in. (100 mm) FULL PORT
 THROUGH
 14 in. x 12 in. (350 mm x 300 mm)
 REDUCED PORT
 NACE MR0175 (Rev. 2002).

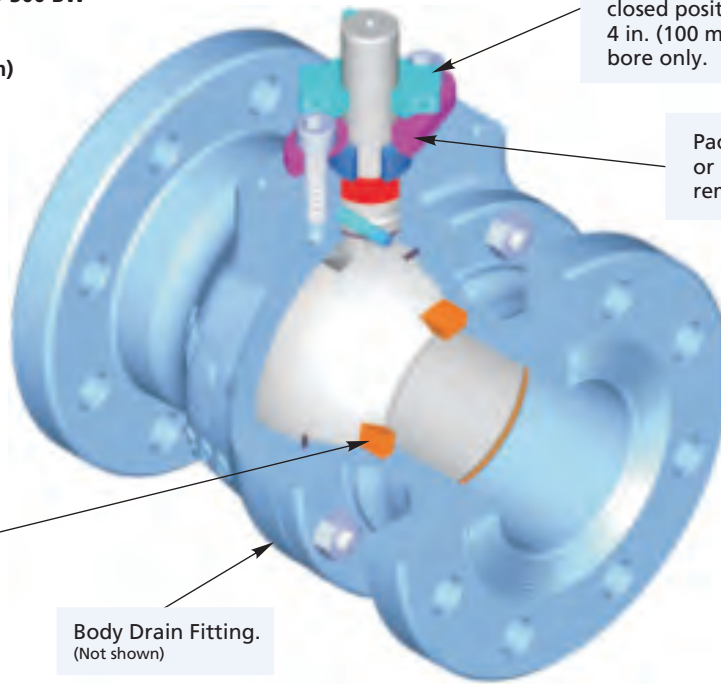

Stop plate provides ball alignment and visual indication of open or closed position
 4 in. (100 mm) and 6 in. (150 mm) bore only.

Packing can be adjusted or replaced without removing valve from line.

Deep seat pockets protects seats from the flow to extend service life.

Body Drain Fitting.
 (Not shown)

ASME/ANSI CLASS 600
 4 in. (100 mm) FULL PORT
 THROUGH
 8 in. x 6 in. (200 mm x 150 mm)
 REDUCED PORT
 NACE MR0175 (Rev. 2002).
 GEAR OPERATORS
 REQUIRED FOR ALL SIZES.

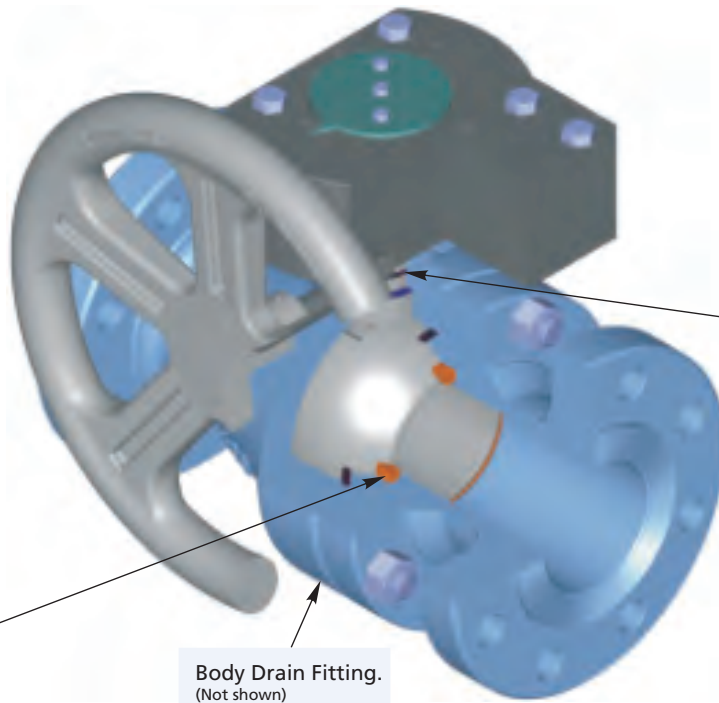

O-Ring stem seal.

Trim 43 Acetal plastic deep pocketed seats.

Body Drain Fitting.
 (Not shown)

WKM DYNASEAL 310

WKM DynaSeal 310 floating ball valves satisfy a wide range of applications. Available in a variety of standard and optional materials, they may be specified in sizes from 4 in. (100 mm) to 14 in. (350 mm) and ASME/ANSI Class 150 and 300. ASME/ANSI Class 600 is available in sizes 4 in. (100 mm) through 8 in. x 6 in. (200 mm x 150 mm). Engineered for heavy duty, maintenance free performance, the WKM DynaSeal 310 is commonly selected for a variety of applications in virtually any industry.

CHEMICAL & PETROCHEMICAL PLANTS
The list of chemical and petrochemical applications for WKM DynaSeal 310 ball valves is limitless. They are serving in many plastic plants handling such slurries as 40% vinyl chloride, in high pressure catalyst lines and in processes handling dry lading such as polyethylene and polystyrene powders. There are hundreds of applications in such plants where WKM DynaSeals 310 are providing efficient service.

REFINING
WKM DynaSeal 310 is the workhorse of the refining industry. The many metal seats, seals and available trims offer the versatility needed to handle the wide variety of products used in the refining process.

HIGH TEMPERATURE SERVICE
Special high temperature trims are available for WKM DynaSeal 310 ball valves which provide for service to 600°F (316°C). This trim is excellent for steam service, hot oil, heat transfer fluids, boiler feed-water and similar applications.

LOW TEMPERATURE SERVICE
Standard trims accommodate temperatures to -20°F (-29°C). For temperatures to -50°F (-46°C); please consult factory.

MAINTENANCE FREE PERFORMANCE
Under most conditions, the WKM DynaSeal 310 floating ball valve will provide years of trouble free service with no maintenance required. In some severe applications, such as handling extremely abrasive slurries at high temperature, it may be necessary to replace the seats occasionally. Seat and seal kits are available and replacement can be done easily with ordinary tools.

SOUR OIL AND GAS SERVICE
WKM DynaSeal 310 ball valves have served for years in gathering lines, manifolds and field processing units in sour oil and gas fields. They can be trimmed to conform with NACE MR0175 (Rev. 2002).

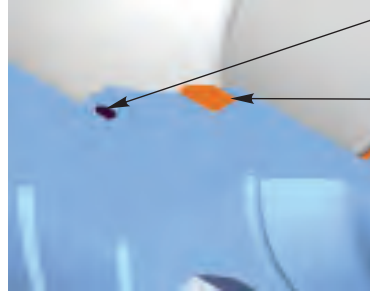

TEFLON BODY SEAL
A Teflon body seal is used between the valve body and tailpiece.

DEEP RECESSED SEATS
The seat is recessed into a deep machined pocket, which serves to surround and protect the seat on all sides. This design eliminates cold flow into the valve conduit where it can be damaged by the action of the ball or the flow medium. The result is extremely long service life.

ADJUSTABLE, REPLACEABLE PACKING
The inline valve stem packing through ASME/ANSI Class 300 consists of PTFE impregnated graphite with an impervious metal barrier. The packing is field adjustable and never requires lubrication. The packing and the stainless steel cap can be replaced without removing the valve from line.

FUGITIVE EMISSIONS
WKM DynaSeal 310 ball valves through ASME/ANSI Class 300 can be supplied and certified to meet the requirements of fugitive emissions as regulated by The 1990 Amendment to The Clean Air Act.

POSITIVELY RETAINED STEM
The stem is positively retained and cannot be removed with the valve in service.

INDICATOR HANDLE
The design of the handle ASME/ANSI Class 300 permits installation on the stem in the correct position only, in alignment with the ball port. When the handle is aligned with the pipe, the valve is open. When the handle is perpendicular to the pipe, the valve is closed.

FLOATING BALL DESIGN DELIVERS TIGHT SEAL
The ground and polished ball is free to float and mates perfectly with the conical seats for a positive, leakproof seal. Self cleaning and self adjusting, the ball is also pressure activated. The higher the line pressure, the tighter the seal.

FEATURES AND BENEFITS

ACTUATION-FRIENDLY
A variety of actuator types can be easily installed, including pneumatic, hydraulic, diaphragm, vane, electro-mechanical and electro-hydraulic.

FIRE-TESTED FOR SAFETY
All WKM DynaSeal 310 valves are qualified under API standard 607 4th Edition. The pocketed seat and locked in stem design contributes to its excellent fire tested characteristics. Should the soft seats be destroyed by fire, the ball floats down stream, providing a tight metal to metal seal against the lip of the seat pocket. If the tailpiece seals are destroyed, the metal to metal tailpiece to body connection retards external leakage.



WKM DynaSeal 310 Ball Valve with Pneumatic Actuator

GEAR MOUNTING BRACKETS FOR:

- | | |
|---|---|
| 4 in. FP - 8 in. RP
(100 mm FP - 200 mm RP)
Class 150/300 | 8 in. FP & 10 in. RP
(200 mm FP & 250 mm RP)
Class 300 |
| 8 in. FP & 10 in. RP
(200 mm FP & 250 mm RP)
Class 150 | 10 in. FP - 14 in. RP
(250 mm FP - 350 mm RP)
Class 150/300 |



WKM DYNASEAL 310

ASME/ANSI CLASS 150, 300 AND 300 BUTT WELD

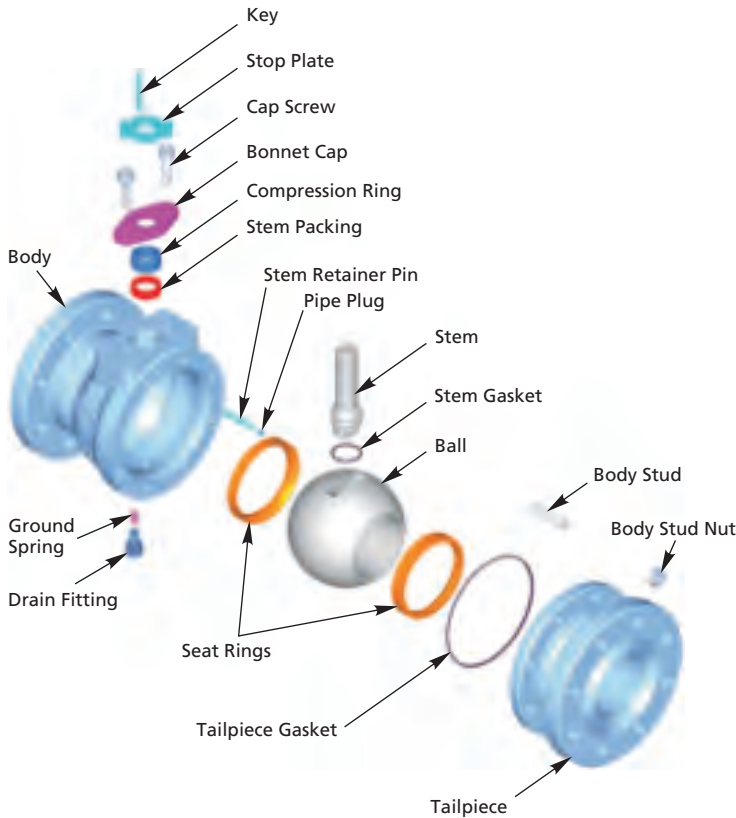

GEAR OPERATOR OPTION



STANDARDS AND SPECIFICATIONS

ASME/ANSI CLASS 150, 300, 600 AND 300 BW

OPERATING TEMPERATURES

- From -50°F to 600°F (-46°F to 316°C)

STANDARD MATERIALS

- Body: Carbon Steel and Stainless Steel
- Ball/Stem: Carbon Steel, Stainless Steel & Monel

INDUSTRY COMPLIANCE

- ASME/ANSI B16.5, B16.34
- MSS-SP-25, 55, 72
- API 607 4th Edition (Fire Test Specifications)

ASME/ANSI CLASS 600

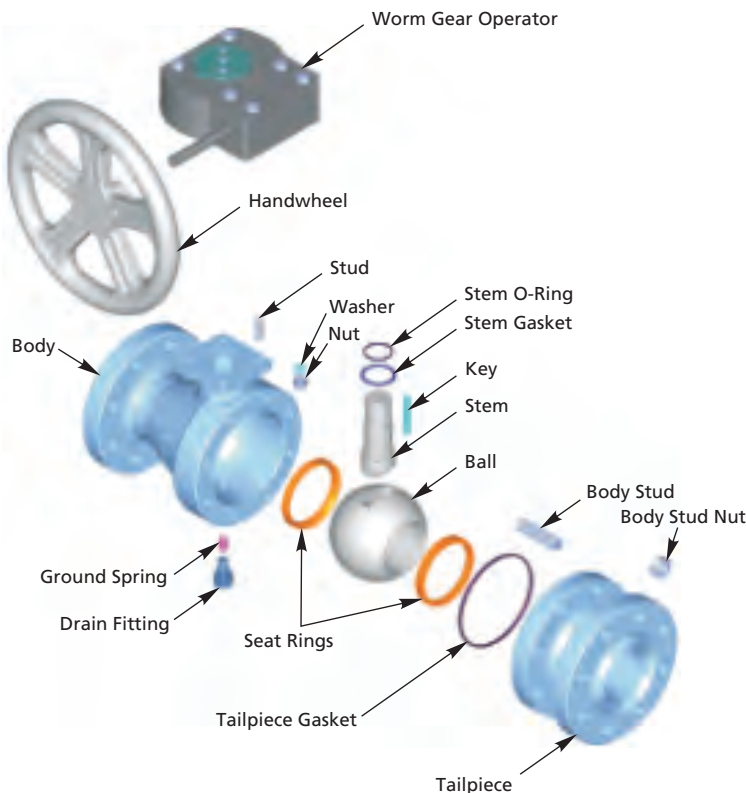

ASME/ANSI PRESSURE CLASS

SIZE	CLASS	CLASS			
		150	300	600	300 BW
in.	(mm)				
4	(100)	FP	•	•	•
6 x 4	(150 x 100)	RP	•	•	•
6	(150)	FP	•	•	•
8 x 6	(200 x 150)	RP	•	•	•
8	(200)	FP	•	•	•
10 x 8	(250 x 200)	RP	•	•	•
10	(250)	FP	•	•	•
12 x 10	(300 x 250)	RP	•	•	•
12	(300)	FP	•	•	•
14 x 12	(350 x 300)	RP	•	•	•

WKM DYNASEAL 310 MATERIALS LIST

4 in. (100 mm) FULL PORT THROUGH 14 in. x 12 in. (350 mm x 300 mm) REDUCED PORT ASME/ANSI CLASS 150, 300 AND 600

BODY/TAIPIECE MATERIAL CODE

PART	CS	CS1*‡	CS2*	S1	S8*
Body	A216 Gr. WCC	A216 Gr. WCC	A216 Gr. WCC	A351 Gr. CF8M	A351 Gr. CF8M
Studs	A193 Gr. B7	A192 Gr. B7	A193 Gr. B7 †	A193 Gr. B7 Plated	A193 Gr. B8
Nuts	A194 Gr. 2H	A194 Gr. 2H	A194 Gr. 2H †	A194 Gr. 2H Plated	A193 Gr. B8
Body Drain Fitting	Carbon Steel	Carbon NACE	Stainless Steel	Stainless Steel	Stainless Steel
Tailpiece**	ASTM A105/A216 Gr. WCC	ASTM A216 Gr. WCC	ASTM A105/A216 Gr. WCC	A351 Gr. CF8M	A351 CF8M
Packing Adjust Studs	A193 Gr. B7	N/A	A193 Gr. B7	A193 Gr. B7 Plated	A193 Gr. B8
Packing Adjust Nuts	A194 Gr. 2H	N/A	A194 Gr. 2H	A194 Gr. 2H Plated	A194 Gr. B8
Packing Adjusting Screws***	Alloy Steel	N/A	Alloy Steel	Alloy Steel Plated	Stainless Steel
Bonnet Cap	A216 Gr. WCC Plated	N/A	A216 Gr. WCC Plated	A216 Gr. WCC Plated	A351 Gr. CF8M

* CS1, CS2 & S8 to be used for H₂S service. Meets NACE MR0175 (Rev. 2002).

** 8 in. (200 mm) through 14 in. x 12 in. (350 mm x 300 mm) ASME/ANSI Class 150 and 300. Only available in A216 Gr. WCC Material.

*** Use only for 4 in. (100 mm) through 8 in. x 6 in. (200 mm x 150 mm) ASME/ANSI Class 150 and 300.

† 4 in through 8 x 6 in. (100 mm through 200 x 150 mm) Class 600 uses A193 Gr. B7M Studs & A194 Gr. 2HM Nuts.

‡ Available in 4 in. through 8 x 6 (100 mm through 200 x 150 mm) ASME/ANSI Class 600 only.

SEAT/SEAL MATERIAL CODE

PART	01	42	43*	18	28	60	92H
Seat	TFE	Filled TFE	-	Special Filled TFE	Filled TFE	Solid Stellite	316 SS Chromium Carbide Coat
Seat Seal	-	-	-	-	-	Graphite	Filled TFE
Tailpiece Gasket	TFE	TFE	FKM O-Ring	Filled TFE	Filled TFE	Filled TFE	Filled TFE
Stem Gasket	TFE	Filled TFE	Nylon Washer	Filled TFE	Filled TFE	Filled TFE	Filled TFE
Packing	Graphite/TFE with SS Cap		FKM O-Ring**	Graphite/TFE with SS Cap			

* Specify Code 43 as standard trim for ASME/ANSI Class 600. Seal set consists of: Acetal Plastic Seats, High Fluorine FKM O-Ring for Tailpiece & Stem.

** Class 600 Valves have FKM O-Ring Stem Seal.

BALL/STEM MATERIAL CODE

PART	CS	S1	S2*	ML
Ball	AISTM A105 Hard Chrome Plate	316 SS	316 SS	B164 Class B Ni-Cu Alloy
Grounding Spring	304 SS	304 SS	304 SS	304 SS
Stem	Carbon Steel ENP	316 SS	Type 630	B164 Class B Ni-Cu Alloy
Compression Ring	304 SS	304 SS	304 SS	304 SS
Stem Retainer Pin	Carbon Steel	316 SS	316 SS	316 SS
Stem Retainer Pipe Plug	Carbon Steel	316 SS	316 SS	316 SS

ACTUATOR CODES*

PART (Body)	For All Body - Tailpiece Trim Codes
Mounting Bracket	Ductile Iron
Adapter Plate	Carbon Steel
Stem Adapter	Carbon Steel
Bolting	Alloy Steel
Key	Carbon Steel
Set Screw	Carbon Steel
Actuator	As Selected
Handwheel	Carbon Steel

ACTUATOR CODES**

PART (Body)	Worm Gear - For All Body Material Codes
Mounting Bracket	Carbon Steel
Bolting	Carbon Steel
Set Screw	Carbon Steel
Stem Adapter	Carbon Steel
Actuator	As Selected
Handwheel	Carbon Steel

** 4 in. through 8 in. (100 mm through 200 mm) ASME/ANSI Class 600.

ACTUATOR CODES (WRENCHES)***

PART (Body)	Wrench - For All Body Material Codes
Wrench Head	Steel
Wrench Handle	Carbon Steel
Wrench Handle Pin	Carbon Steel
Cap Screw	Alloy Steel
Stop plate	Carbon Steel

*** 4 in. through 8 in. x 6 in. (100 mm through 200 mm x 150 mm) ASME/ANSI Class 150 and 300.

* 10 in. through 14 in. x 12 in. (250 mm through 350 mm x 300 mm) ASME/ANSI Class 150 and 300.

WKM DYNASEAL 310

4 in. (100 mm) FULL PORT THROUGH 14 in. (350 mm) REDUCED PORT ASME/ANSI CLASS 150, 300, 600 AND BUTT WELD 300

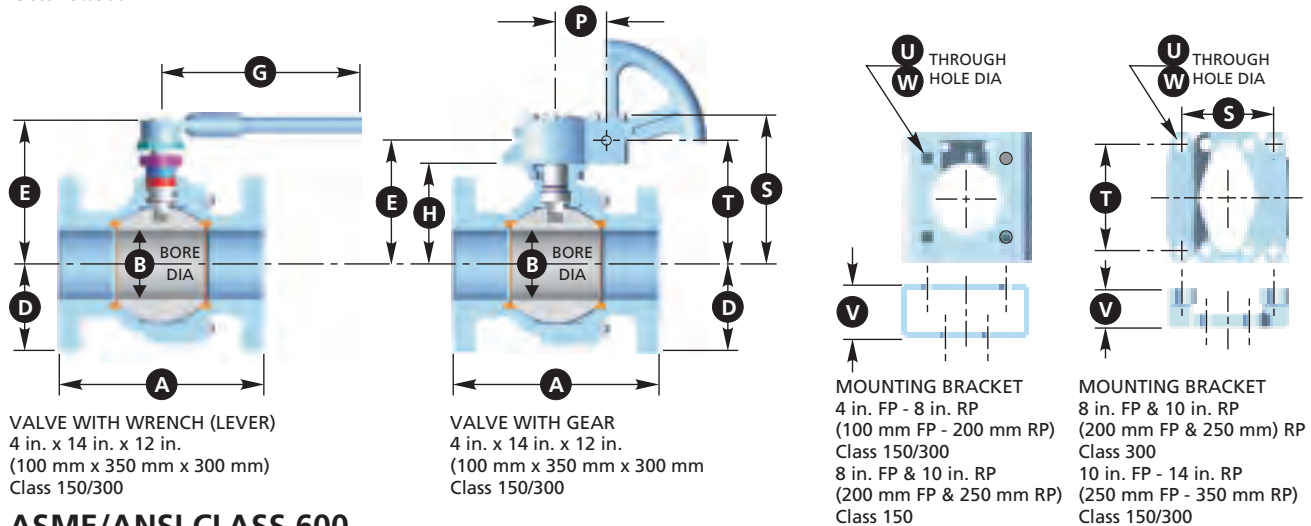
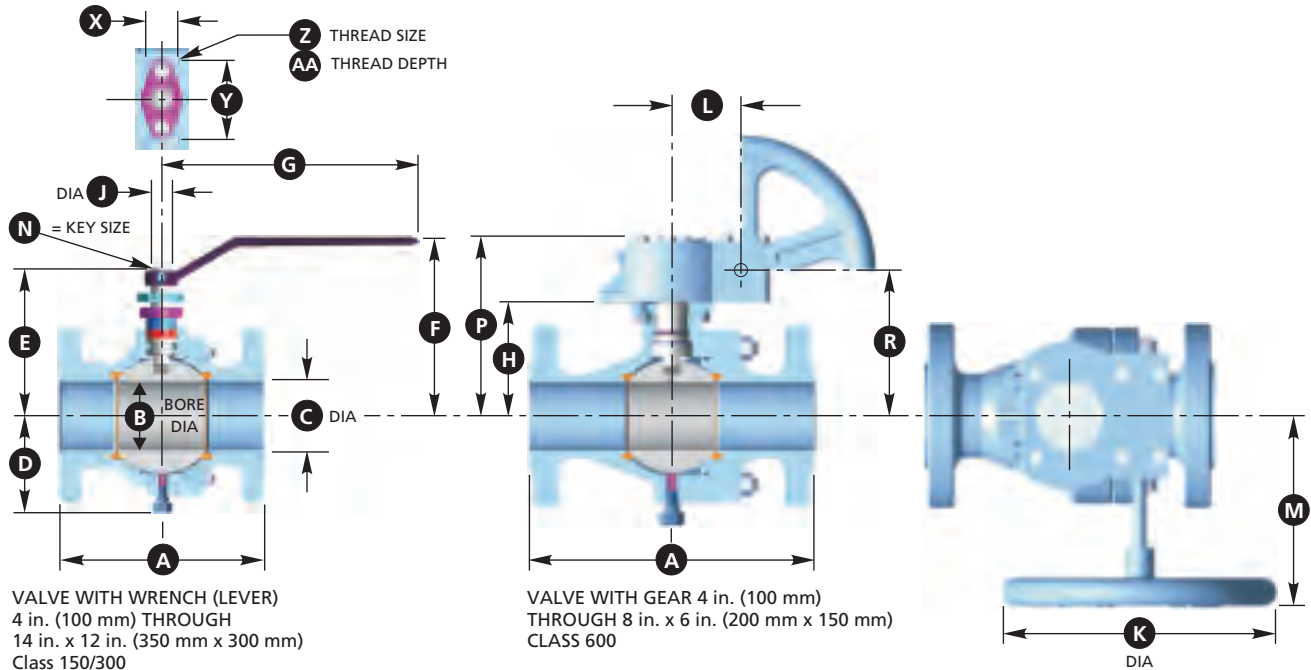

ASME/ANSI CLASS 600 FULL PORT DIMENSIONS

SIZE in.	A	B	C	D	H	K	L	M	P	R
4	17.00	4.00	4.00	6.52	6.81	20.00	2.50	9.72	9.79	8.18
6	22.00	6.00	6.00	8.17	9.28	24.00	4.84	14.26	13.43	11.25
SIZE mm										
100	432	102	102	166	173	508	64	247	249	208
150	559	152	152	208	236	610	123	362	341	286

REDUCED PORT DIMENSIONS

SIZE in.	A	B	C	D	H	K	L	M	P	R
6 x 4	22.00	4.00	6.00	6.52	6.81	20.00	2.50	9.72	9.79	8.18
8 x 6	26.00	6.00	8.00	8.17	9.28	24.00	4.84	14.26	13.43	11.25
SIZE mm										
150 x 100	559	102	152	166	173	508	64	247	249	208
200 x 150	660	152	203	208	236	610	123	362	341	286

WKM DYNASEAL 310 4 in. (100 mm) FULL PORT THROUGH 14 in. (350 mm) REDUCED PORT ASME/ANSI CLASS 150, 300, 600 AND BUTT WELD 300

FULL PORT DIMENSIONS

SIZE in.	A* Class					B	C	D	E	F	G	H	J	K	L	M	N	P	R	S	T	U	V	W	X	Y	Z	AA
	150 RF		300 RF		300																							
	LONG B110	SHORT B113	LONG B128	SHORT B134	BW B150																							
4	9.00	-	-	-	-	4.0	4.0	6.47	8.63	9.88	36.0	7.56	1.250	8.0	2.80	7.88	0.250	10.84	9.15	-	-	0.56	2.44	4.921	1.88	4.63	3/8-16NC	0.63
	-	N/A	12.00	N/A	12.00	4.0	4.0	6.47	8.63	9.88	36.0	7.56	1.250	10.0	2.80	8.12	0.250	10.84	9.15	-	-	0.56	2.44	4.921	1.88	4.63	3/8-16NC	0.63
6	15.50	10.50	-	-	-	6.0	6.0	8.20	11.38	12.63	48.0	9.44	1.500	14.0	2.80	10.95	0.375	12.72	11.03	-	-	0.56	2.44	4.921	1.88	4.63	3/8-16NC	0.63
	-	-	15.88	N/A	15.88	6.0	6.0	8.20	11.38	12.63	48.0	9.44	1.500	14.0	4.11	13.24	0.375	13.28	11.33	-	-	0.56	2.44	4.921	1.88	4.63	3/8-16NC	0.63
8	18.00	-	-	-	-	8.0	8.0	9.95	16.38	-	-	13.50	2.375	16.0	4.11	11.11	0.625	17.34	15.39	-	-	0.68	4.00	5.512	3.50	8.25	1-8NC	1.13
	-	N/A	19.75	16.50	16.50	8.0	8.0	9.97	16.38	-	-	12.50	2.375	20.0	5.12	15.25	0.625	17.07	14.67	-	-	0.75	3.00	-	3.50	8.25	1-8NC	1.13
10	21.00	-	-	-	-	10.0	10.0	11.63	18.50	-	-	15.12	2.938	20.0	5.12	15.25	0.750	19.70	17.30	7.75	5.75	0.75	3.00	-	3.50	8.25	1-8NC	1.13
	-	N/A	22.38	-	22.00	10.0	10.0	11.65	18.50	-	-	15.12	2.938	20.0	8.31	17.61	0.750	21.24	17.30	7.75	5.75	0.75	3.00	-	3.50	8.25	1-8NC	1.13
12	24.00	-	-	-	-	12.0	12.0	13.97	20.13	-	-	16.38	2.938	20.0	8.31	17.61	0.750	22.49	18.55	7.75	5.75	0.75	3.00	-	3.50	8.25	1-8NC	1.13
	-	N/A	25.50	N/A	25.00	12.0	12.0	13.97	20.13	-	-	16.38	2.938	24.0	8.31	17.61	0.750	22.49	18.55	7.75	5.75	0.75	3.00	-	3.50	8.25	1-8NC	1.13

mm

SIZE in.	A* Class					B	C	D	E	F	G	H	J	K	L	M	N	P	R	S	T	U	V	W	X	Y	Z	AA
	150 RF		300 RF		300																							
	LONG B110	SHORT B113	LONG B128	SHORT B134	BW B150																							
100	229	-	-	-	-	102	102	164	219	251	914	192	31.75	203	71	200	6.35	275	232	-	-	14	62	124.99	48	118	3/8-16NC	16
	-	N/A	305	N/A	305	102	102	164	219	251	914	192	31.75	254	71	206	6.35	275	232	-	-	14	62	124.99	48	118	3/8-16NC	16
150	394	267	-	-	-	152	152	208	289	321	1219	240	38.10	356	71	278	9.53	323	280	-	-	14	62	124.99	48	118	3/8-16NC	16
	-	-	403	N/A	403	152	152	208	289	321	1219	240	38.10	356	104	336	9.53	337	280	-	-	14	62	124.99	48	118	3/8-16NC	16
200	457	-	-	-	-	203	203	253	416	-	-	343	60.33	406	104	282	15.88	440	391	-	-	17	102	140.00	89	210	1-8NC	29
	-	N/A	502	419	419	203	203	253	416	-	-	318	60.33	508	130	387	15.88	434	373	-	-	19	76	-	89	210	1-8NC	29
250	533	-	-	-	-	254	254	295	470	-	-	384	74.63	508	130	387	19.05	500	439	197	146	19	76	-	89	210	1-8NC	29
	-	N/A	568	-	559	254	254	295	467	-	-	384	74.63	504	212	444	22.75	535	439	197	146	19	76	-	89	210	1-8NC	29
300	610	-	-	-	-	305	305	355	511	-	-	416	74.63	508	211	447	19.05	571	471	197	146	19	76	-	89	210	1-8NC	29
	-	N/A	648	N/A	635	305	305	355	511	-	-	416	74.63	610	211	447	19.05	571	471	197	146	19	76	-	89	210	1-8NC	29

REDUCED PORT DIMENSIONS

SIZE in.	A* Class				B	C	D	E	F	G	H	J	K	L	M	N	P	R	S	T	U	V	W	X	Y	Z	AA
	150 RF		300 RF																								
	LONG B100	SHORT B102	LONG B120	SHORT B122																							
6 x 4	N/A	10.50	-	N/A	4.00	6.00	6.45	8.63	9.88	36.00	7.56	1.250	8.00	2.80	7.88	0.250	10.84	9.15	-	-	0.56	2.44	4.921	1.88	4.63	3/8-16NC	0.63
	-	-	15.88	-	4.00	6.00	6.45	8.63	9.88	36.00	7.56	1.250	10.00	2.80	8.12	0.250	10.84	9.15	-	-	0.56	2.44	4.921	1.88	4.63	3/8-16NC	0.63
8 x 6	18.00	11.50	-	-	6.00	8.00	8.20	11.38	12.63	48.00	9.44	1.500	14.00	2.80	10.95	0.375	12.72	11.03	-	-	0.56	2.44	4.921	1.88	4.63	3/8-16NC	0.63
	-	-	-	N/A	16.50	6.00	8.00	8.20	11.38	12.63	48.00	9.44	1.500	16.00	4.11	11.11	0.375	13.28	11.33	-	-	0.56	2.44	4.921	1.88	4.63	3/8-16NC
10 x 8	21.00	-	-	-	8.00	10.00	10.10	16.38	-	-	13.50	2.375	20.00	4.11	13.64	0.625	17.34	15.39	-	-	0.68	4.00	5.512	3.50	8.25	1-8NC	1.13
	-	N/A	22.38	N/A	8.00	10.00	10.10	16.38	-	-	12.50	2.375	20.00	5.12	15.25	0.625	17.07	14.67	-	-	0.75	3.00	-	3.50	8.25	1-8NC	1.13
12 x 10	24.00	-	-	-	10.00	12.00	11.78	18.50	-	-	15.12	2.938	24.00	5.12	15.25	0.750	19.70	17.30	7.75	5.75	0.75	3.00	-	3.50	8.25	1-8NC	1.13
	-	N/A	25.50	N/A	10.00	12.00	11.78	18.50	-	-	15.12	2.938	20.00	8.31	17.61	0.750	21.24	17.30	7.75	5.75	0.75	3.00	-	3.50	8.25	1-8NC	1.13
14 x 12	27.00	-	-	-	12.00	14.00	13.97	20.13	-	-	16.38	2.938	20.00	8.31	17.61	0.750	22.49	18.55	7.75	5.75	0.75	3.00	-	3.50	8.25	1-8NC	1.13
	-	N/A	30.00	N/A	12.00	14.00	13.97	20.13	-	-	16.38	2.938	24.00	8.31	17.61	0.750	22.49	18.55	7.75	5.75	0.75	3.00	-	3.50	8.25	1-8NC	1.13

mm

SIZE mm	A* Class				B	C	D	E	F	G	H	J	K	L	M	N	P	R	S	T	U	V	W	X	Y	Z	AA
	150 RF		300 RF																								
	LONG B100	SHORT B102	LONG B120	SHORT B122																							
150 x 100	N/A	267	-	N/A	102	152	164	219	251	914	192	31.75	203	71	200	6.35	275	232	-	-	14	62	124.99	48	118	3/8-16NC	16
	-	-	403	-	102	152	164	219	251	914	192	31.75	254	71	206	6.35	275	232	-	-	14	62	124.99	48	118	3/8-16NC	16
200 x 150	457	292	-	-	152	203	208	289	321	1219	240	38.10	356	71	278	9.53	323	280	-	-	14	62	124.99	48	118	3/8-16NC	16
	-	-	-	N/A	419	152	203	208	289	321	1219	240	38.10	406	104	282	9.53	337	288	-	-	14	62	124.99	48	118	3/8-16NC
250 x 200	533	-	-	-	203	254	257	416	-	-	343	60.33	508	104	346	15.88	440	391	-	-	17	102	140.00	89	210	1-8NC	29
	-	N/A	568	N/A	203	254	257	416	-	-	318	60.33	508	130	387	15.88	434	373	-	-	19	76	-	89	210	1-8NC	29
300 x 250	610	-	-	-	254	305	299	470	-	-	384	74.63	610	130	387	19.05	500	439	197	146	19	76	-	89	210	1-8NC	29
	-	N/A	648	N/A	254	305	299	470	-	-	384	74.63	508	211	447	19.05	539	439	197	146	19	76	-	89	210	1-8NC	29
350 x 300	N/A	-	-	-	305	356	355	511	-	-	416	74.63	508	211	447	19.05	571	471	197	146	19	76	-	89	210	1-8NC	29
	-	N/A	762	N/A	305	356	355	511	-	-	416	74.63	610	211	447	19.05	571	471	197	146	19	76	-	89	210	1-8NC	29

* Centerline-to-face dimension is half of dimension A, except:

4 in. (100 mm) ASME/ANSI Class 150 Full Port - stem is offset 1/2 in. (12.7 mm) towards body end and 6 in. (150 mm).
ASME/ANSI Class 150 Full Port Long Pattern - stem is offset 2 1/2 in. (63.5 mm) towards body end.

PRESSURE/TEMPERATURE FOR ALL WKM DYNASEAL 310 VALVES

WKM DynaSeal 310 Ball Valves are rated for high performance and long life.

The ratings shown here are based on tests which indicate good seat performance and acceptable wear.

This rating is determined by the lower of the valve's pressure or seat rating.

The seat rating is the maximum differential pressure to which the valve should be subjected on a continuous basis.

Seal codes 01, 02, 42 & 07 are suitable for vacuum service to 20 microns, absolute (minimum temperature 0°F (-18°C)).

SEAL CODE 01

Temp °F	Temp °C	Valve Port Size in. (mm)				
		1/4 - 3/4 (80 - 20)	1 - 1 1/2 (25 - 40)	2 (50)	3 - 4 (80 - 100)	6 - 12 (150 - 300)
-50 to 100	-46 to 38	1500	1000	750	600	285
200	93	1500	1000	750	600	285
250	121	1400	900	700	550	150
300	149	1100	650	500	425	50
350	177	600	375	300	250	-
400	204	100	100	100	100	-

SEAL CODE 42

Temp °F	Temp °C	Valve Port Size in. (mm)		
		1/4 - 1 1/2 (8 - 40)	2 (50)	3 (80)
-50 to 100	-46 to 38	1500	1500	740
200	93	1400	1325	740
250	121	1250	1150	740
300	149	1090	975	740
350	177	930	800	590
400	204	770	640	450
450	232	610	475	325
500	260	450	300	200

SEAL CODE 43, 48

Temp °F	Temp °C	Valve Port Size in. (mm)				
		1/4 - 1 1/2 (8 - 40)	2 (50)	3 (80)	4 (100)	6 (150)
-50 to 100	-46 to 38	3000	3000	1500	1500	1500
200	93	3000	3000	1500	1500	1500
220	104	3000	3000	1375	1375	1375

SEAL CODE 07*

Temp °F	Temp °C	Valve Port Size in. (mm)		
		1/4 - 1 1/2 (8 - 40)	2 (50)	3 (80)
-20 to 100	-29 to 38	740*	500*	285*
350	177	500	350	200
400	204	250	190	100

* Block and Bleed Range.

SEAL CODE 42, 28

Temp °F	Temp °C	Valve Port Size in. (mm)	
		4 (100)	6 - 12 (150 - 300)
-50 to 100	-46 to 38	740	740
250	121	740	675
300	149	740	550
350	177	590	410
400	204	400	300
450	232	325	175
500	260	200	65

SEAL CODE 18

Temp °F	Temp °C	Valve Port Size in. (mm)			
		1/4 - 1 1/2 (8 - 40)	2 (50)	3 (80)	4 - 12 (100 - 300)
-50 to 100	-46 to 38	*	*	*	*
200	93	*	*	*	*
250	121	1775	1250	*	*
300	149	1650	1175	740	600
350	177	1575	1075	700	500
400	204	1500	1000	650	400
450	232	1300	875	600	300
500	260	1075	725	550	200
550	288	850	600	500	100
600	316	350	100	75	0
625	329	100	0	0	0

* On Application.

SEAL CODE 23

Temp °F	Temp °C	Valve Port Size in. (mm)	
		1/4 - 3/8 (8 - 10)	1/2 - 3/4 (15 - 20)
-50 to 100	-46 to 38	5000	3750
200	93	3250	2000
225	107	2500	1500

SEAL CODE 60, 92H

Temp °F	Temp °C	Trim 60/60A	Trim 92H
		-50 to 100	-46 to 38
200	93	675	680
250	121	665	675
300	149	655	650
350	177	645	575
400	204	635	475
450	232	617	375
500	260	600	275
550	288	575	200
600	316	550	100

PRESSURE/TEMPERATURE LIMITS FOR WKM DYNASEAL 310 VALVE BODY ASSEMBLIES

FLANGED VALVES

Data is maximum working pressure ratings for the valve body assembly at various temperatures. Practical pressure limitations according to actual service conditions are determined by the seal and tailpiece gasket materials.

MAXIMUM WORKING PRESSURES psig

TEMP °F VALVE CLASS	BODY MATERIAL CODES					
	CS, CS2 & CS3			S1 & S8		
	150	300	600	150	300	600
-20 to 100	285	740	1480	275	720	1440
150	272	707	1415	255	670	1340
200	260	675	1350	235	620	1240
250	245	665	1332	225	590	1180
300	230	655	1315	215	560	1120
350	215	645	1292	205	537	1073
400	200	635	1270	195	515	1025
450	185	617	1235	182	497	990
500	170	600	1200	170	480	955
550	155	575	1147	155	465	928
600	140	550	1095	140	450	900

MAXIMUM WORKING PRESSURES -bars (1 bar = 14.5 psi)

TEMP °C VALVE CLASS	BODY MATERIAL CODES					
	CS, CS2 & CS3			S1 & S8		
	20PN	50PN	100PN	20PN	50PN	100PN
-29 to 38	20	51	102	19	50	100
66	19	49	98	18	46	92
93	18	47	93	16	43	85
121	17	46	92	16	41	81
149	16	45	91	15	39	77
177	15	44	89	14	37	74
204	14	44	88	13	36	71
232	13	43	85	13	34	68
260	12	41	83	12	33	66
288	11	40	79	11	32	64
316	10	38	75	10	31	62

THREADED VALVES

Body trim code S8 and CS3 are suitable for service to -50°F (-46°C).

All other trims are limited to operating temperatures no lower than -20°F (-29°C)

These pressure/temperature ratings are in conformance with ASME/ANSI B16.5, B16.34.

MAXIMUM WORKING PRESSURES - psig

TEMP °F VALVE BORE SIZE in.	BODY MATERIAL CODES									
	CS, CS2 & CS3					S1 & S8				
	1/4 - 3/8	1/2 - 3/4	1 - 1 1/2	2	3	1/4 - 3/8	1/2 - 3/4	1 - 1 1/2	2	3
-20 to 100	5000	3750	3000	2000	1500	5000	3750	3000	2000	1500
150	4779	3583	2867	1912	1434	4650	3487	2790	1861	1396
200	4557	3416	2734	1824	1368	4301	3224	2580	1722	1292
250	4494	3368	2696	1800	1350	4092	3068	2455	1639	1229
300	4431	3320	2658	1775	1333	3884	2912	2330	1556	1167
350	4355	3264	2613	1744	1310	3725	2794	2236	1491	1117
400	4278	3209	2567	1713	1287	3566	2677	2141	1426	1068
450	4161	3120	2496	1665	1252	3442	2583	2066	1377	1031
500	4043	3031	2425	1618	1216	3317	2489	1992	1328	995
550	3868	2900	2320	1548	1163	3225	2419	1936	1291	966
600	3694	2768	2215	1478	1110	3134	2349	1880	1254	938

MAXIMUM WORKING PRESSURE - bars (1 bar = 14.5 psi)

TEMP °C VALVE BORE SIZE mm	BODY MATERIAL CODES									
	CS, CS2 & CS3					S1 & S8				
	8 - 10	15 - 20	25 - 40	50	80	8 - 10	15 - 20	25 - 40	50	80
-29 to 38	345	259	207	138	103	345	259	207	138	103
66	330	247	198	132	99	321	240	192	128	96
93	314	236	189	126	94	297	222	178	119	89
121	310	232	186	124	93	282	212	169	113	85
149	306	229	183	122	92	268	201	161	107	80
177	300	225	180	120	90	257	193	154	103	77
204	295	221	177	118	89	246	185	148	98	74
232	287	215	172	115	86	237	178	143	95	71
260	279	209	167	112	84	229	172	137	92	69
288	267	200	160	107	80	222	167	134	89	67
316	255	191	153	102	77	216	162	130	86	65

WKM DYNASEAL 310 WEIGHTS

VALVE SIZE in.	(mm)	END CONNECTION	FULL PORT WEIGHT		REDUCED PORT WEIGHT	
			lb.	kg	lb.	kg
1/4	(6)	Threaded	1.50	0.68	-	-
3/8	(10)	Threaded	1.50	0.68	-	-
1/2	(15)	Threaded	1.50	0.68	1.50	0.68
1/2	(15)	150 (20 PN) Flanged (Unibody)	3.80	1.70	-	-
1/2	(15)	300 (50 PN) Flanged (Unibody)	5.00	2.30	-	-
3/4	(20)	Threaded	3.25	1.47	-	-
3/4	(20)	150 (20 PN) Flanged (Unibody)	-	-	5.70	2.60
3/4	(20)	300 (50 PN) Flanged (Unibody)	-	-	7.50	3.40
1	(25)	Threaded	5.00	2.30	3.00	1.36
		150 (20 PN) Flanged	8.50	3.86	6.3	2.86
		300 (50 PN) Flanged	12.00	5.44	-	-
		300 (50 PN) Flanged (Unibody)	-	-	8.80	4.00
		600 (100 PN) Flanged	32.00	14.50	-	-
1 1/2	(40)	Threaded	12.00	5.44	-	-
		150 (20 PN) Flanged	17.00	7.71	-	-
		300 (50 PN) Flanged	24.00	10.90	-	-
		600 (100 PN) Flanged	32.00	14.50	-	-
2	(50)	Threaded	23.00	10.40	12.50	5.67
		150 (20 PN) Flanged	33.00	15.00	23.00	10.40
		300 (50 PN) Flanged	38.00	17.20	25.00	11.30
		600 (100 PN) Flanged	47.00	21.30	33.00	15.00
3	(80)	Threaded	56.00	25.40	36.00	16.30
		150 (20 PN) Flanged	64.00	29.00	51.00	23.10
		300 (50 PN) Flanged	81.00	36.70	76.00	35.00
		600 (100 PN) Flanged	87.00	39.50	81.00	36.70
4	(100)	Threaded	-	-	67.00	30.40
		150 (20 PN) Flanged	-	-	80.00	36.30
		300 (50 PN) Flanged	-	-	127.00	57.60
		600 (100 PN) Flanged	-	-	130.00	59.00

VALVE SIZE in.	(mm)	END CONNECTION	FULL PORT WEIGHT		REDUCED PORT WEIGHT	
			lb.	kg	lb.	kg
4	(100)	150 (L) Flanged	113	51	-	-
		300 (L) Flanged	144	65	-	-
		Butt Weld	94	43	-	-
		600 Flanged	257	117	-	-
6	(150)	150 (L) Flanged	162	73	-	-
		150 (S) Flanged	144	65	125	57
		300 (L) Flanged	273	124	193	88
		Butt Weld	189	86	139	63
6	(150)	150 (L) Flanged	176	80	-	-
		150 (S) Flanged	158	72	133	60
		300 (L) Flanged	313	142	223	101
		Butt Weld	203	92	154	70
6	(150)	600 Flanged	545	247	363	165
		150 (L) Flanged	388	176	217	98
		150 (S) Flanged	-	-	197	89
		300 (S) Flanged	437	198	293	133
8	(200)	Butt Weld	328	149	237	108
		150 (L) Flanged	428	194	231	105
		150 (S) Flanged	-	-	211	96
		300 (L) Flanged	477	216	307	139
8	(200)	WGA	517	235	-	-
		300 (L) Flanged	368	167	251	114
		Butt Weld	-	-	648	294
		600 Flanged	-	-	-	-
10	(250)	150 (L) Flanged	695	315	451	205
		WGA	736	334	-	-
		300 (L) Flanged	858	389	587	266
		WGA	953	432	-	-
10	(250)	300 (L) Flanged	610	277	365	166
		Butt Weld	-	-	-	-
		150 (L) Flanged	943	428	791	359
		WGA	1038	471	-	-
12	(300)	WGA	1262	572	971	440
		300 (L) Flanged	1522	690	-	-
		WGA	815	370	740	336
		Butt Weld	-	-	-	-
14	(350)	150 (L) Flanged	-	-	985	447
		WGA	-	-	1350	612
		300 (L) Flanged	-	-	1022	464

(S) Short Pattern. (L) Long Pattern.

WKM DYNASEAL 310 WEIGHTS

VALVE SIZE		MOP	MALE x FEMALE THREADED ENDS			
in.	(mm)		FULL PORT WEIGHTS		REDUCED PORT WEIGHTS	
			lb.	kg	lb.	kg
1/2	(15)	3000	-	-	3	1.36
1/2	(15)	5000	-	-	3	1.36
3/4	(20)	3000	6	2.72	-	-
3/4	(20)	3750	6	2.72	-	-
1	(25)	3000	-	-	7	3.18
1	(25)	3750	-	-	7	3.18
SOCKET WELD ENDS						
1/4	(8)	3000	2	0.91	-	-
1/2	(15)	3000	-	-	3	1.36
3/4	(20)	3000	6	2.72	-	-
1	(25)	3000	-	-	6	2.72
1 1/2	(40)	3000	19	8.62	-	-
2	(50)	3000	-	-	21	9.53

FLOW CHARACTERISTICS (C_v)*

VALVE SIZE AND PORT SIZE		THREADED END VALVES	VALVE PRESSURE CLASS		
in.	(mm)		150	300	600
1/4 x 1/4	(8 x 8)	9	-	-	-
3/8 x 3/8	(10 x 10)	9	-	-	-
1/2 x 3/8	(15 x 10)	5	-	-	-
1/2 x 1/2	(15 x 15)	16	16	14	-
3/4 x 1/2	(20 x 15)	-	10	10	-
3/4 x 3/4	(20 x 20)	45	-	-	-
1 x 3/4	(25 x 20)	20	35	34	-
1 x 1	(25 x 25)	93	88	77	68
1 1/2 x 1 1/2	(40 x 40)	248	223	208	184
2 x 1 1/2	(50 x 40)	80	102	101	99
2 x 2	(50 x 50)	491	464	421	362
3 x 2	(80 x 50)	107	117	133	133
3 x 3	(80 x 80)	1099	1228	1042	928
4 x 3	(100 x 80)	322	359	410	406
4 x 4	(100 x 100)	-	2118	2446	-
6 x 4	(150 x 100)	-	390	391 (S)	-
6 x 6	(150 x 150)	-	5403	6644 (S) / 5468 (L)	-
8 x 6	(200 x 150)	-	1215	1219 (S) / 1215 (L)	-
8 x 8	(200 x 200)	-	11261	10782	-
10 x 8	(250 x 200)	-	2671	2672	-
10 x 10	(250 x 250)	-	17037	17438	-
12 x 10	(300 x 250)	-	4881	4885	-
12 x 12	(300 x 300)	-	26163	26702	-
14 x 12	(350 x 300)	-	10580	10076	-

* Flow of water in U.S. Gallons per minute per 1 psi pressure drop across a fully open valve.

(S) Short Pattern.

(L) Long Pattern.

WKM DYNASEAL 310 STEM TORQUES (in. lb.)

SEAT SEAL CODES 01

VALVE BORE SIZE		DIFFERENTIAL PRESSURE				
in.	(mm)	0-285	500	740	1000	1500
1/4 - 3/8 (8 - 10)		36	36	36	36	42
1/2	(15)	60	60	60	72	72
3/4	(20)	90	90	90	120	180
1	(25)	120	150	180	225	-
1 1/2	(40)	240	330	420	520	-
2	(50)	500	640	810	-	-
3	(80)	1200	1800	2400	-	-

SEAT SEAL CODES 42**

VALVE BORE SIZE		DIFFERENTIAL PRESSURE				
in.	(mm)	0-285	500	740	1000	1500
1/4 - 3/8 (8 - 10)		36	36	36	36	42
1/2	(15)	60	60	60	72	72
3/4	(20)	90	90	90	120	180
1	(25)	120	150	180	225	300
1 1/2	(40)	240	330	420	520	720
2	(50)	500	640	810	1090	1440
3	(80)	1200	1800	2400	-	-

** Multiply Trim 42 Torque x 2 for Seat Seal Codes 60, 92H.

SEAT SEAL CODES 43, 48

VALVE BORE SIZE		DIFFERENTIAL PRESSURE								
in.	(mm)	0-285	500	740	1000	1500	2000	2250	2500	3000
1/4 - 3/8 (8 - 10)		48	48	48	50	55	60	70	85	100
1/2	(15)	58	60	64	70	90	120	140	165	215
3/4	(20)	90	95	105	125	175	230	260	295	370
1	(25)	225	245	260	280	320	400	455	520	700
1 1/2	(40)	390	410	450	510	700	920	1050	1200	1550
2	(50)	860	960	1075	1210	1500	1830	2000	2200	2600
3	(80)	1450	1635	1885	2220	3050	-	-	-	-

SEAT SEAL CODES 18

VALVE BORE SIZE		DIFFERENTIAL PRESSURE					
in.	(mm)	0-285	500	740	1000	1500	2250
1/4 - 3/8 (8 - 10)		60	60	60	60	72	84
1/2	(15)	60	60	60	70	84	108
3/4	(20)	128	128	145	160	215	360
1	(25)	274	284	312	360	405	580
1 1/2	(40)	520	580	680	810	980	1390
2	(50)	910	1042	1240	1500	1765	2300
3	(80)	1200	1800	2400	2900	3420	-

SEAT SEAL CODES 07

VALVE BORE SIZE		LIQUID	DRY GAS	DRY GAS
in.	(mm)	0-285 psi	0-285 psi	740 psi
1/4 - 3/8 (8 - 10)		36	42	113
1/2	(15)	60	82	220
3/4	(20)	90	150	404
1	(25)	180	336	606
1 1/2	(40)	420	840	2260
2	(50)	900	1200	3230
3	(80)	2400	3600	9690

WKM DYNASEAL 310 STEM TORQUES (in. lb.)

SEAT SEAL CODE 23

VALVE BORE SIZE		DIFFERENTIAL PRESSURE													
in.	(mm)	0-285	500	740	1000	1500	2000	2250	2500	3000	3500	3750	4000	4500	5000
1/4 - 3/8 (8 - 10)		60	60	60	60	60	65	70	85	100	115	125	130	150	165
1/2	(15)	70	70	70	82	110	125	140	180	220	276	310	-	-	-
3/4	(20)	108	108	125	140	190	260	340	420	560	695	800	-	-	-

SEAT SEAL CODE 01

VALVE BORE SIZE		DIFFERENTIAL PRESSURE (psi)		
in.	(mm)	0-285	500	740
4	(100)	2090	3300	4200
6	(150)	4400	8200	11200
8	(200)	9000	14000	20300
10	(250)	15000	22000	30500
12	(300)	29300	37400	46400

SEAT SEAL CODES 28, 42** & 18

VALVE BORE SIZE		DIFFERENTIAL PRESSURE (psi)		
in.	(mm)	0-285	500	740
4	(100)	2400	3300	4200
6	(150)	5400	8200	11200
8	(200)	10000	15000	20300
10	(250)	16000	23000	30500
12	(300)	32000	39000	46500

** Multiply Trim 42 Torque x 2 for Seat Seal Codes 60, 92H.

Note: The torque values listed for 285 psi and greater are based on valves controlling the flow of clean lubricating liquid at ambient temperature.

For valves at pressure less than 285 psi use the value for 285 psi.

Interpolation may be used for any pressure above 285 psi but less than maximum pressure listed.

Running torque values will average two-thirds of these values.

For running torque values less than breakaway torque values at 285 psi use breakaway torque values.

Reseating torque is equal to breakaway torque.

For operating temperatures between -20°F to -50°F (-29°C to -46°C) multiply these values by 1.20.

These torque values do not contain service or safety factors.

Actuator selection should be made based on experience and appropriate service and safety factors.

WKM DYNASEAL MATERIAL SELECTION GUIDE

A selection of body, stem and seat/seal materials for WKM DynaSeal valves are available. The following list is intended as a guide in the selection of materials for corrosive service.

No material can be expected to resist the corrosive action of all the many ladings found in modern industry. Experience has shown, however, that certain materials can perform satisfactorily within certain limits.

The physical properties of a material are affected differently by each corrosive medium. Therefore, it sometimes becomes necessary to sacrifice value in another property. As a result, the user must decide which property is of prime importance for his application.

Internal moving parts, in contact with the lading, should always carry an "A" rating. Body materials with exposure to corrosive ladings can sometimes carry "B" rating because metal loss due to corrosive is not as critical.

The following information is designed for use by technically qualified individuals at there own discretion and risk.

We strongly recommend that tests be run under actual operating conditions to obtain a material's performance ability in any one corrosive medium.

Rating interpretation:

- "A" - excellent;
- "B" - good (slightly attacked);
- "C" - fair (moderately attacked, robably unsuitable);
- "D" - not recommended.

LADING	STD BDY CS	STD BDY S1	STD BDY CS2	STD BDY S8	SPL BDY CS3	SPL 01	STD 42	SPL 18	SPL 07	STD 43	STD INT CS	STD INT S1	SPL INT S2	SPL INT ML
ACETALDEHYDE	C	A	C	A	C	A	A	A	D	B	C	A	C	A
ACETATE SOLVENTS	A	A	A	A	A	A	A	A	D	B	A	A	A	A
ACETIC ACID (30%)	C	A	C	A	C	A	A	A	B	D	C	A	C	A
ACETIC ACID (AERATED)	D	A	D	A	D	A	A	A	D	D	D	A	D	A
ACETIC ACID (AIR FREE)	D	A	D	A	D	A	A	A	D	D	D	B	D	A
ACETIC ACID (CRUDE)	C	A	C	A	C	A	A	A	D	D	C	A	C	A
ACETIC ANHYDRIDE	D	B	D	B	D	A	A	A	D	D	D	B	D	A
ACETONE	A	A	A	A	A	A	A	A	D	B	A	A	A	A
ACETYLENE (DRY ONLY)	A	A	A	A	A	A	A	A	A	D	A	A	A	A
ACRYLONITRILE	A	A	A	A	A	A	A	A	C	C	A	A	A	A
ALCOHOL-AMYL	B	A	B	A	B	A	A	A	B	B	B	A	B	A
ALCOHOL-BUTYL	B	A	B	A	B	A	A	A	A	C	B	A	B	A
ALCOHOL-ETHYL	B	A	B	A	B	A	A	A	C	B	B	A	B	A
ALCOHOL-METHYL (METHANOL)	B	A	B	A	B	A	A	A	D	C	B	A	B	A
ALUMINUM CHLORIDE (DRY)	B	A	B	A	B	A	A	A	A	D	B	A	B	A
ALUMINUM SULFATE (ALUMS)	C	A	C	A	C	A	A	A	A	B	C	A	C	A
ALUM'S	C	A	C	A	C	A	A	A	A	C	C	A	C	A
AMINES	A	A	A	A	A	A	A	A	B	C	A	A	A	A
AMINES BASED-CORROSION INHIBITOR	A	A	A	A	A	A	A	A	-	B	A	A	A	A
AMINES RICH	D	A	A	A	A	A	A	A	-	C	D	A	A	A
AMMONIA (AQUEOUS)	A	A	A	A	A	A	A	A	D	D	A	A	A	B
AMMONIA ANHYDROUS	A	A	A	A	A	A	A	A	D	D	A	A	A	B
AMMONIA SOLUTIONS	B	A	B	A	B	A	A	A	D	D	B	A	B	B
AMMONIUM BICARBONATE	C	B	C	B	C	A	A	A	B	D	C	B	C	B
AMMONIUM CARBONATE	B	B	B	B	B	A	A	A	B	D	B	B	B	B
AMMONIUM CHLORIDE	D	C	D	C	D	A	A	A	A	B	D	C	D	B
AMMONIUM HYDROXIDE (28%)	C	B	C	B	C	A	C	C	B	C	C	B	C	D
AMMONIUM HYDROXIDE CONCENTRATED	C	B	C	B	C	A	C	C	D	D	C	B	C	D
AMMONIUM MONOPHOSPHATE	D	B	D	B	D	A	A	A	B	B	D	B	D	C
AMMONIUM NITRATE	D	A	D	A	D	A	A	A	C	C	D	A	D	D
AMMONIUM PHOSPHATE (DIBASIC)	D	B	D	B	D	A	A	A	A	C	D	B	D	C
AMMONIUM PHOSPHATE (TRIBASIC)	D	B	D	B	D	A	A	A	A	C	D	B	D	C
AMMONIUM SULFATE	C	B	C	B	C	A	A	A	A	C	B	C	C	C
AMYL ACETATE	C	B	C	B	C	A	A	A	D	B	C	B	C	B
ANILINE	A	B	A	B	A	A	A	A	C	C	A	B	A	B
ANILINE DYES	C	A	C	A	C	A	A	A	B	C	C	A	C	A
ANTIMONY TRICHLORIDE	D	D	D	D	D	A	A	A	A	D	D	D	D	B
APPLE JUICE	D	B	D	B	D	A	A	A	A	A	D	B	D	A
ARSENIC ACID	D	B	D	B	D	A	A	A	A	A	D	B	D	D
ASPHALT EMULSION	A	A	A	A	A	A	A	A	A	B	A	A	A	A
ASPHALT LIQUID	A	A	A	A	A	A	A	A	A	B	A	A	A	A
BARIUM CARBONATE	B	B	B	B	B	A	A	A	A	A	B	B	B	B
BARIUM CHLORIDE	C	C	C	C	C	A	A	A	A	A	C	C	C	B
BARIUM HYDROXIDE	C	B	C	B	C	A	A	A	A	A	C	B	C	B
BARIUM SULFATE	B	B	B	B	B	A	A	A	A	A	B	B	B	A
BARIUM SULFIDE	B	B	B	B	-	A	A	A	A	A	C	B	-	B
BEER (ALCOHOL INDUSTRY)	C	A	C	A	C	A	A	A	A	A	C	A	C	A
BEER (BEVERAGE INDUSTRY)	C	A	C	A	C	A	A	A	A	A	C	A	C	A

(-) - Not tested.

VTFEP - Virgin TFE Packing.

Note: All ladings at ambient temperatures except as noted.

WKM DYNASEAL MATERIAL SELECTION GUIDE (CONTINUED)

LADING	STD BDY CS	STD BDY S1	STD BDY CS2	STD BDY S8	SPL BDY CS3	SPL 01	STD 42	SPL 18	SPL 07	STD 43	STD INT CS	STD INT S1	SPL INT S2	SPL INT ML
BEET SUGAR LIQUIDS	B	A	B	A	B	A	A	A	A	A	B	A	B	A
BENZALDEHYDE	A	A	A	A	A	A	A	A	D	A	A	A	A	A
BENZENE (BENZOL)	B	A	B	A	B	A	A	A	A	B	B	A	B	A
BENZOIC ACID	D	B	D	B	D	A	A	A	A	C	D	B	D	B
BORAX LIQUORS	C	B	C	B	C	A	A	A	A	A	C	B	C	A
BORIC ACID	D	A	D	A	D	A	A	A	A	A	D	A	D	A
BRINES	C	B	C	B	C	A	A	A	A	A	C	B	C	A
BROMINE (DRY)	D	D	D	D	D	A	A	A	A	C	D	D	D	A
BROMINE (WET)	D	D	D	D	D	A	A	A	B	D	D	D	D	B
BUNKER OILS (FUEL OILS)	B	A	B	A	B	A	A	A	A	A	B	A	B	A
BUTADIENE	B	A	B	A	B	A	C	D	A	B	B	A	B	C
BUTANE	A	A	A	A	A	A	A	A	A	A	B	A	B	A
BUTTERMILK	D	A	D	A	D	A	A	A	A	A	D	A	D	D
BUTYLENE	A	A	A	A	A	A	A	A	A	B	A	A	A	A
BUTYRIC ACID	D	B	D	B	D	A	A	A	B	C	D	B	D	B
CALCIUM BISULFITE	D	B	D	B	D	A	A	A	B	D	D	B	D	B
CALCIUM CARBONATE	D	B	D	B	D	A	A	A	A	A	D	B	D	B
CALCIUM CHLORIDE	C	B	C	B	C	A	A	A	A	A	C	B	C	A
CALCIUM HYDROXIDE (20%)	B	B	B	B	B	A	A	A	A	A	B	B	B	A
CALCIUM HYPOCHLORITE	D	C	D	C	D	A	A	A	A	D	D	A	D	C
CALCIUM SULFATE	C	B	C	B	C	A	A	A	A	A	C	B	C	B
CARBON BISULFIDE	B	B	B	B	B	A	A	A	A	D	B	B	B	A
CARBON DIOXIDE (DRY)	A	A	A	A	A	A	A	A	D	A	A	A	A	A
CARBON DIOXIDE (WET)	D	B	D	B	-	A	A	A	D	A	D	A	A	A
CARBON TETRACHLORIDE (DRY)	B	A	B	A	B	A	A	A	A	B	B	A	B	A
CARBON TETRACHLORIDE (WET)	D	B	D	B	D	A	A	A	A	C	D	B	D	B
CARBONATED WATER	B	A	B	A	B	A	A	A	A	A	B	A	B	A
CARBONIC ACID	D	B	D	B	D	A	A	A	A	B	D	B	D	A
CASTOR OIL	B	A	B	A	B	A	A	A	A	A	B	A	B	A
CHINA WOOD OIL (TUNG)	C	A	C	A	C	A	A	A	A	A	C	A	C	A
CHLORINATED SOLVENTS (DRY)	C	B	C	B	C	A	A	A	A	B	C	B	C	B
CHLORINE (WET)	D	D	D	D	D	A	A	A	A	D	D	D	D	C
CHLORINE GAS (DRY)	B	B	B	B	B	A	A	A	A	D	B	B	B	B
CHLOROACETIC ACID	D	C	D	C	D	A	A	A	D	D	D	D	D	B
CHLOROBENZENE (DRY)	B	A	B	A	B	A	A	A	A	B	B	A	B	A
CHLOROFORM (DRY)	B	A	B	A	B	A	A	A	A	B	B	A	B	A
CHLOROSULPHONIC ACID (DRY)	B	B	B	B	B	A	A	A	D	D	B	B	B	A
CHLOROSULPHONIC ACID (WET)	D	D	D	D	D	A	A	A	D	D	D	D	D	C
CHROME ALUM	B	A	B	A	B	A	A	A	A	C	B	A	B	B
CHROMIC ACID	D	C	D	C	D	A	A	A	A	D	D	C	D	B
CITRUS JUICES	D	B	D	B	D	A	A	A	A	A	D	B	D	A
COCONUT OIL	C	B	C	B	C	A	A	A	A	A	C	B	C	B
COFFEE EXTRACTS (HOT)	C	A	C	A	C	A	A	A	A	A	C	A	C	A
COKE OVEN GAS	B	A	B	A	B	A	A	A	A	D	B	A	B	B
COOKING OIL	B	A	B	A	B	A	A	A	A	B	B	A	B	A
COPPER ACETATE (10%)	C	B	C	B	C	A	A	A	D	A	C	B	C	B
COPPER CHLORIDE	D	D	D	D	D	A	A	A	A	A	D	D	D	C
COPPER NITRATE	D	B	D	B	D	A	A	A	A	A	D	B	D	C
COPPER SULFATE	D	C	D	C	D	A	A	A	A	B	D	C	D	B
CORN OIL	C	B	C	B	C	A	A	A	A	A	C	B	C	B
CORROSION INHIBITOR- AMINE BASED	A	A	A	A	A	A	A	A	-	B	A	A	A	A
COTTONSEED OIL	C	B	C	B	C	A	A	A	A	A	C	B	C	B
CREOSOTE OIL	B	B	B	B	B	A	A	A	A	C	B	B	B	A
CRESYLIC ACID	B	B	B	B	B	A	A	A	A	C	B	B	B	B
CRUDE OIL SOUR	B	A	B	A	B	A	A	A	A	B	B	A	B	A
CRUDE OIL SWEET	B	A	B	A	B	A	A	A	A	A	B	A	B	A
CUTTING OILS, WATER EMULSIONS	B	A	B	A	B	A	A	A	A	B	B	A	B	-
CYCLOHEXANE	A	A	A	A	A	A	A	A	A	A	A	A	A	A
DIACETONE ALCOHOL	A	A	A	A	A	A	A	A	D	C	A	A	A	A
DIESEL FUEL	A	A	A	A	A	A	A	A	A	A	A	A	A	A
DIETHYLAMINE	A	A	A	A	A	A	A	A	HF	C	A	A	A	A
DIPHHTALIC ANHYDROUS	-	-	-	-	-	-	A	-	-	-	-	-	-	-
DOWTHERMS (A-E)	B	A	B	A	B	A	A	A	A	B	B	A	B	A

(-) - Not tested.

VTFEP - Virgin TFE Packing.

Note: All ladings at ambient temperatures except as noted.

WKM DYNASEAL MATERIAL SELECTION GUIDE (CONTINUED)

LADING	STD BDY CS	STD BDY S1	STD BDY CS2	STD BDY S8	SPL BDY CS3	SPL 01	STD 42	SPL 18	SPL 07	STD 43	STD INT CS	STD INT S1	SPL INT S2	SPL INT ML
DRILLING MUD	B	A	B	A	B	A	A	A	A	A	B	A	B	A
DRIP COCKS, GAS	B	A	B	A	B	A	A	A	A	A	B	A	B	A
DRY CLEANING FLUIDS	B	A	B	A	B	A	A	A	A	B	B	A	B	B
EPSOM SALT	C	B	C	B	C	A	A	A	A	A	C	B	C	B
ETHANE	A	A	A	A	A	A	A	A	A	A	A	A	A	A
ETHANOLAMINE	A	A	A	A	A	A	A	A	D	C	A	A	A	A
ETHERS	B	A	B	A	B	-	A	A	D	A	B	A	B	B
ETHYL ACETATE	B	B	B	B	B	A	A	A	D	C	B	B	B	B
ETHYL ACRYLATE	A	A	A	A	A	A	A	A	B	C	A	A	A	A
ETHYL CHLORIDE (DRY)	B	A	B	A	B	A	A	A	A	B	B	A	B	B
ETHYL CHLORIDE (WET)	B	B	B	B	B	A	A	A	A	B	B	B	B	B
ETHYLENE (LIQUID OR GAS)	A	A	A	A	A	A	-	-	A	B	A	A	A	A
ETHYLENE GLYCOL	B	B	B	B	B	A	A	A	A	A	B	B	B	B
ETHYLENE OXIDE	B	B	B	B	B	A	A	A	D	B	B	B	B	B
FATTY ACIDS	D	B	D	B	D	A	A	A	A	B	D	B	D	B
FERRIC CHLORIDE	D	D	D	D	D	A	A	A	A	A	D	D	D	C
FERRIC NITRATE	D	C	D	C	D	A	A	A	A	A	D	C	D	C
FERRIC SULFATE	D	B	D	B	D	A	A	A	A	A	D	B	D	B
FERROUS CHLORIDE	D	D	D	D	D	A	A	A	A	A	D	D	D	C
FERROUS SULFATE	D	B	D	B	D	A	A	A	A	A	D	B	D	B
FERROUS SULFATE (SAT)	C	A	C	A	C	A	A	A	-	C	C	A	C	A
FERTILIZER SOLUTIONS	B	B	B	B	B	A	A	A	D	D	B	B	B	B
FISH OILS	B	A	B	A	B	A	A	A	A	A	B	A	B	A
FLUORINE (DRY)	B	A	B	A	B	C	C	C	C	C	B	A	B	A
FLUROSILICIC ACID	D	C	D	C	D	A	-	-	A	C	D	C	D	C
FOOD FLUIDS - PASTES	C	A	C	A	C	A	A	A	A	A	C	A	C	A
FORMALDEHYDE (COLD)	A	A	A	A	A	A	A	A	D	A	A	A	A	A
FORMALDEHYDE (HOT)	D	B	D	B	D	A	A	A	D	B	D	B	D	B
FORMIC ACID (COLD)	D	B	D	B	D	A	A	A	C	D	D	B	D	B
FORMIC ACID (HOT)	D	D	D	D	D	A	A	A	C	D	D	D	D	B
FREON 12 (DRY)	B	A	B	A	B	A	A	A	B	B	B	A	B	A
FRUIT JUICES	D	A	D	A	D	A	A	A	A	A	D	A	D	A
FUEL JET JP-4	A	A	A	A	A	A	A	A	A	A	A	A	A	A
FUEL JET JP-5 100F	A	A	A	A	A	A	A	A	B	A	A	A	A	A
FUEL JET JP-6 100F	A	A	A	A	A	A	A	A	B	A	A	A	-	A
FUEL OIL	B	A	B	A	B	A	A	A	A	A	B	A	B	A
FUEL RP-1	A	A	A	A	A	A	A	A	A	A	A	A	A	A
FURFURAL	A	B	A	B	A	A	A	A	D	B	A	B	A	A
GALLIC ACID	D	B	D	B	D	A	A	A	A	C	D	B	D	B
GAS (MANUFACTURED)	B	B	B	B	B	A	A	A	A	A	B	B	B	A
GAS ODORIZERS (VTFEP)	B	A	B	A	B	A	A	A	A	-	B	A	B	B
GAS, NATURAL	B	A	B	A	B	A	A	A	A	A	B	A	B	A
GASOLINE, AVIATION	A	A	A	A	A	A	A	A	A	A	A	A	A	A
GASOLINE, SOUR	B	A	B	A	B	A	A	A	A	B	B	A	B	A
GASOLINE, LEADED, LOW OCTANE	A	A	A	A	A	A	A	A	A	A	A	A	A	A
GASOLINE, UNLEADED, LOW OCTANE	A	A	A	A	A	A	A	A	A	A	A	A	A	A
GELATIN	D	A	D	A	D	A	A	A	A	A	D	A	D	A
GLUCOSE	B	A	B	A	B	A	A	A	A	A	B	A	B	A
GLUE	A	A	A	A	A	A	A	A	A	A	A	A	A	A
GLYCERINE - GLYCEROL	B	A	B	A	B	A	A	A	A	A	B	A	B	A
GLYCOLS	B	B	B	B	B	A	A	A	A	A	B	B	B	B
GREASE	A	A	A	A	A	A	A	A	A	A	A	A	A	B
HEPTANE	A	A	A	A	A	A	A	A	A	A	A	A	A	A
HEXANE	A	A	A	A	A	A	A	A	A	A	A	A	A	A
HEXANOL, TERTIARY	A	A	A	A	A	A	A	A	A	B	A	A	A	A
HYDRAULIC OIL PHOSPHATE ESTER	A	A	A	A	A	A	A	A	A	B	A	A	A	A
HYDRAULIC OIL PETROLEUM BASE	A	A	A	A	A	A	A	A	A	A	A	A	A	A
HYDROBROMIC ACID	D	D	D	D	D	A	A	A	A	D	D	D	D	C
HYDROCHLORIC ACID 37% AIR FREE	D	D	D	D	D	A	A	A	B	D	D	D	D	B
HYDROCYANIC ACID	D	B	D	B	D	A	-	-	B	D	D	B	D	A
HYDROFLUORIC ACID	D	D	D	D	D	A	C	C	D	D	D	D	D	B
HYDROFLUOSILICIC ACID	D	C	D	C	D	A	A	A	A	D	D	C	D	B

(-) - Not tested.

VTFEP - Virgin TFE Packing.

Note: All ladings at ambient temperatures except as noted.

WKM DYNASEAL MATERIAL SELECTION GUIDE (CONTINUED)

LADING	STD BDY CS	STD BDY S1	STD BDY CS2	STD BDY S8	SPL BDY CS3	SPL 01	STD 42	SPL 18	SPL 07	STD 43	STD INT CS	STD INT S1	SPL INT S2	SPL INT ML
HYDROGEN GAS (COLD)	B	A	B	A	B	A	A	A	B	A	B	A	B	A
HYDROGEN PEROXIDE 30% (DILUTE)	D	B	D	B	D	A	A	A	B	D	D	B	D	B
HYDROGEN PEROXIDE 90%	D	B	D	B	D	A	A	A	B	D	D	D	B	D
HYDROGEN SULFIDE (DRY)	D	D	A	A	A	A	A	A	A	D	D	D	A	A
HYDROGEN SULFIDE (WET)	D	D	B	A	B	A	B	A	A	A	D	D	A	A
HYPO (SODIUM THIOSULFATE)	D	A	D	A	D	A	A	A	A	B	D	A	D	B
HYPOCHLORITES, SODIUM	D	C	D	C	D	A	A	A	A	D	D	C	D	B
ILLUMINATING GAS	A	A	A	A	A	A	A	A	-	A	A	A	A	A
INK	D	A	D	A	D	A	A	A	-	A	D	A	D	B
IODINE (WET)	D	D	D	D	D	A	A	A	B	B	D	D	D	D
ISO-OCTANE	A	A	A	A	A	A	A	A	A	A	A	A	A	A
ISODOFORM (DRY)	B	B	B	B	B	A	A	A	-	-	B	B	B	B
SOPROPYL ALCOHOL	B	B	B	B	B	A	A	A	B	B	B	B	-	B
ISOPROPYL ETHER	A	A	A	A	A	A	A	A	D	C	A	A	A	A
KEROSENE	B	A	B	A	B	A	A	A	A	A	B	A	B	A
KETCHUP	D	A	D	A	D	A	A	A	A	A	D	A	D	B
KETONES	A	A	A	A	A	A	A	A	D	A	A	A	A	A
LACQUERS (SOLVENTS)	C	A	C	A	C	A	A	A	D	C	C	A	C	A
LACTIC ACID (CONC. COLD)	D	A	D	A	D	A	A	A	A	B	D	B	D	D
LACTIC ACID (CONC. HOT)	D	B	D	B	D	A	A	A	A	D	D	B	D	D
LACTIC ACID (DILUTE COLD)	D	A	D	A	D	A	A	A	A	A	D	A	D	C
LACTIC ACID (DILUTE HOT)	D	A	D	A	D	A	A	A	A	D	D	B	D	D
LARD OIL	C	A	C	A	C	A	A	A	A	A	C	A	C	B
LEAD ACETATE	D	B	C	B	C	A	A	A	D	C	D	B	D	B
LINOLEIC ACID	B	A	B	A	B	A	A	A	C	C	B	A	B	B
LINSEED OIL	A	A	A	A	A	A	A	A	A	A	A	A	A	B
LIQUEFIED PET GAS (LPG)	B	A	B	A	B	A	A	A	A	A	B	A	B	B
LITHIUM BROMIDE	D	A	D	A	D	A	A	A	-	-	D	A	-	A
LUBRICATING OIL	A	A	A	A	A	A	A	A	A	A	A	A	A	B
MAGNESIUM BISULFATE (10%)	C	A	C	A	C	A	A	A	A	A	C	A	C	B
MAGNESIUM CHLORIDE	C	D	C	D	C	A	A	A	A	C	C	D	C	B
MAGNESIUM HYDROXIDE	B	A	B	A	B	A	A	A	A	A	B	A	B	A
MAGNESIUM HYDROXIDE (HOT)	B	A	B	A	B	A	A	A	B	A	B	A	B	A
MAGNESIUM SULFATE	B	B	B	B	B	A	A	A	A	C	B	B	B	B
MALEIC ACID	B	C	B	C	B	A	A	A	A	C	B	C	B	B
MALEIC ANHYDRIDE	D	A	D	A	D	-	A	A	-	-	D	A	B	A
MALIC ACID	D	A	D	A	D	A	A	A	A	C	D	A	D	B
MAYONNAISE	D	A	D	A	D	A	A	A	A	A	D	A	D	B
MERCAPTANS	A	A	A	A	A	A	A	A	A	-	A	A	A	D
MERCURIC CHLORIDE	D	D	D	D	D	A	A	A	A	A	D	D	D	D
MERCURIC CYANIDE (10%)	D	B	D	B	D	A	A	A	-	B	D	B	D	D
MERCURY	A	A	A	A	A	A	A	A	A	A	A	A	A	C
METHANE	A	A	A	A	A	A	A	A	A	A	A	A	A	A
METHYL ACETATE	A	A	A	A	A	A	A	A	D	B	A	A	A	A
METHYL ACETONE	A	A	A	A	A	A	A	A	D	C	A	A	A	A
METHYL CELLOSOLVE	B	B	B	B	B	A	A	A	D	B	B	B	B	B
METHYL CHLORIDE (DRY)	B	A	B	A	B	A	A	A	A	-	B	A	B	A
METHYL ETHYL KETONE	A	A	A	A	A	A	A	A	D	A	A	A	A	A
METHYL FORMATE	B	B	B	B	B	A	A	A	-	B	B	B	B	B
METHYLAMINE	B	B	B	B	B	A	A	A	-	C	B	B	B	B
METHYLENE CHLORIDE (DRY)	B	B	B	B	B	A	A	A	B	B	B	B	B	B
MILK	D	A	D	A	D	A	A	A	A	A	D	A	D	A
MINE WATERS (ACID)	D	B	D	B	D	A	A	A	B	C	D	B	D	B
MINERAL SPRITS	B	B	B	B	B	A	A	A	A	A	B	B	B	B
MINERAL OIL	B	A	B	A	B	A	A	A	A	A	B	A	B	A
MIXED ACIDS (COLD)	C	A	C	A	C	A	A	A	-	D	C	A	C	B
MOLASSES - CRUDE	A	A	A	A	A	A	A	A	A	A	A	A	A	A
MOLASSES, EDIBLE	A	A	A	A	A	A	A	A	A	A	A	A	A	A
MTBE 100% MAX	B	A	B	A	B	A	B	A	D	B	B	A	A	A
MTBE 40% MAX	A	A	A	A	A	D	A	A	D	B	-	A	A	A
MURIATIC ACID	D	D	D	D	D	A	A	A	A	D	D	D	D	B
MUSTARD	B	A	B	A	B	A	A	A	A	A	B	A	B	A

(-) - Not tested.

VTFEP - Virgin TFE Packing.

Note: All ladings at ambient temperatures except as noted.

WKM DYNASEAL MATERIAL SELECTION GUIDE (CONTINUED)

LADING	STD BDY CS	STD BDY S1	STD BDY CS2	STD BDY S8	SPL BDY CS3	SPL 01	STD 42	SPL 18	SPL 07	STD 43	STD INT CS	STD INT S1	SPL INT S2	SPL INT ML
NAPHTHA	B	A	B	A	B	A	A	A	A	A	B	A	B	B
NAPHTHALENE	A	A	A	A	A	A	A	A	A	B	A	A	A	B
NICKEL AMMONIUM SULFATE (20%)	D	A	D	A	D	A	A	A	A	A	D	A	D	D
NICKEL CHLORIDE	D	B	D	B	D	A	A	A	A	D	D	B	D	B
NICKEL NITRATE (30%)	D	B	D	B	D	A	A	A	A	C	D	B	D	B
NICKEL SULFATE	D	C	D	C	D	A	A	A	A	C	D	C	D	B
NICOTINIC ACID	B	A	B	A	B	A	A	A	-	C	B	A	B	A
NITRIC ACID (10%) (VTFEP)	D	A	D	A	D	A	B	B	A	D	D	A	D	D
NITRIC ACID (100%) (VTFEP)	A	A	A	A	A	A	B	B	D	D	A	A	A	D
NITRIC ACID (30%) (VTFEP)	D	A	D	A	D	A	B	B	A	D	D	A	D	D
NITRIC ACID (80%) (VTFEP)	D	A	D	A	D	A	B	B	C	D	D	A	D	D
NITRIC ACID ANHYDROUS/AQUEOUS (VTFEP)	A	A	A	A	A	A	B	B	D	D	A	A	A	D
NITROBENZENE	B	B	B	B	B	A	A	A	B	C	B	B	B	B
NITROGEN	A	A	A	A	A	A	A	A	A	A	A	A	A	A
NITROUS ACID (10%)	D	B	D	B	D	A	A	A	A	D	D	B	D	D
NITROUS GASES	B	A	B	A	B	A	A	A	A	B	B	A	B	D
NITROUS OXIDE	A	B	A	B	A	A	A	A	A	A	A	B	A	D
OIL, COTTONSEED	C	B	C	B	C	A	A	A	A	A	C	B	C	B
OIL, PETROLEUM (REFINED)	A	A	A	A	A	A	A	A	A	A	A	A	A	A
OIL, PETROLEUM (SOUR) H ₂ S & CO ₂	D	D	A	A	A	A	A	A	B	A	A	A	A	A
OIL, WATER MIXTURES	B	A	B	A	B	A	A	A	B	A	B	A	B	A
OIL, ANIMAL	A	A	A	A	A	A	A	A	A	A	A	A	A	A
OIL, FISH	B	A	B	A	B	A	A	A	A	A	B	A	B	A
OIL, FUEL	B	A	B	A	B	A	A	A	A	A	B	A	B	A
OIL, LUBE	A	A	A	A	A	A	A	A	A	A	A	A	A	B
OIL, MINERAL	B	A	B	A	B	A	A	A	A	A	B	A	B	A
OLEIC ACID	B	A	B	A	B	A	A	A	A	A	B	A	B	B
OLEUM	B	B	B	B	B	A	A	A	A	D	B	B	B	D
OLIVE OIL	B	A	B	A	B	A	A	A	D	B	B	A	B	A
OXALIC ACID	D	D	D	D	D	A	A	A	B	C	D	D	D	B
OXYGEN	B	A	B	A	B	A	A	A	A	C	B	A	B	A
OZONE (DRY)	A	A	A	A	A	A	A	A	A	C	A	A	A	A
OZONE (WET)	C	A	C	A	C	A	A	A	A	C	C	A	C	A
PAINTS AND THINNERS	A	A	A	A	A	A	A	A	A	B	A	A	A	A
PALM OIL	C	B	C	B	C	A	A	A	A	A	C	B	C	A
PALMITIC ACID	C	A	C	A	C	A	A	A	A	B	C	A	C	B
PARAFFIN	B	A	B	A	B	A	A	A	A	B	B	A	B	A
PARAFORMALDEHYDE	B	B	B	B	B	A	A	A	C	A	B	A	B	B
PENTANE	B	A	B	A	B	A	A	A	A	A	B	A	B	B
PERCHLOROETHYLENE	B	B	B	B	B	A	A	A	A	B	B	B	B	A
PETROLATUM	C	B	C	B	C	A	A	A	A	A	C	B	C	A
PHENOL (CARBOLIC ACID)	B	A	B	A	B	A	A	A	A	B	B	A	B	A
PHENOL RESIN	C	A	C	A	C	A	D	A	A	D	C	A	A	A
PHOSGENE (DRY) (VTFEP)	A	A	A	A	A	-	A	A	B	-	A	A	A	A
PHOSGENE (WET) (VTFEP)	D	A	D	A	D	B	A	A	A	-	D	A	A	A
PHOSPHORIC ACID (10%) COLD	D	B	D	B	D	A	A	A	A	D	D	B	D	B
PHOSPHORIC ACID (10%) HOT	D	D	D	D	D	A	A	A	A	D	D	D	D	C
PHOSPHORIC ACID (50%) COLD	D	B	D	B	D	A	A	A	A	D	D	B	D	C
PHOSPHORIC ACID (50%) HOT	D	D	D	D	D	A	A	A	A	D	D	D	D	C
PHOSPHORIC ACID (85%) COLD	B	A	B	A	B	A	A	A	A	D	B	A	B	A
PHOSPHORIC ACID (85%) HOT	C	A	C	A	C	A	A	A	A	D	C	A	C	A
PHTHALIC ACID	C	B	C	B	C	A	A	A	A	C	C	A	C	A
PHTHALIC ANHYDRIDE	C	B	C	B	C	A	A	A	A	B	C	B	C	C
PICRIC ACID	C	B	C	B	C	A	A	A	A	D	C	B	C	A
PINE OIL	B	A	B	A	B	A	A	A	A	A	B	A	B	A
PINEAPPLE JUICE	C	A	C	A	C	A	A	A	A	A	C	A	C	A
POLY ESTER RESIN (VTFEP)	-	A	-	A	-	-	-	-	-	-	-	A	A	A
POLYETHYLENE FLUFF	B	A	B	A	B	-	-	-	-	-	-	A	A	A
POLYETHYLENE LIQUID	B	A	-	A	-	-	-	-	A	-	B	A	A	A
POLYURETHANE	A	A	A	A	A	-	A	A	D	D	A	A	A	A
POTASSIUM BISULFITE (10%)	D	B	D	B	D	A	A	A	A	A	D	D	B	A
POTASSIUM BROMIDE	D	B	D	B	D	A	A	A	-	A	D	B	D	B

(-) - Not tested.

VTFEP - Virgin TFE Packing.

Note: All loadings at ambient temperatures except as noted.

WKM DYNASEAL MATERIAL SELECTION GUIDE (CONTINUED)

LADING	STD BDY CS	STD BDY S1	STD BDY CS2	STD BDY S8	SPL BDY CS3	SPL 01	STD 42	SPL 18	SPL 07	STD 43	STD INT CS	STD INT S1	SPL INT S2	SPL INT ML
POTASSIUM CARBONATE	C	A	C	A	C	A	A	A	A	A	C	A	C	B
POTASSIUM CHLORATE	B	A	B	A	B	A	A	A	A	A	B	A	B	B
POTASSIUM CHLORIDE	C	A	C	A	C	A	A	A	A	A	C	A	C	B
POTASSIUM CYANIDE	B	B	B	B	B	A	A	A	A	C	B	B	B	B
POTASSIUM DICHROMATE	B	A	B	A	B	A	A	A	A	C	B	A	B	B
POTASSIUM DIPHOSPHATE	A	A	A	A	A	A	A	A	A	A	A	A	A	B
POTASSIUM FERRICYANIDE	B	A	B	A	B	A	A	A	A	A	B	B	B	B
POTASSIUM FERROCYANIDE	B	A	B	A	B	A	A	A	A	A	B	A	B	A
POTASSIUM HYDROXIDE 70% (COLD)	B	B	B	B	B	A	B	B	D	C	B	B	B	A
POTASSIUM HYDROXIDE 70% (HOT)	A	A	A	A	A	A	B	B	D	C	A	A	A	A
POTASSIUM HYDROXIDE-DILUTE (COLD)	B	B	B	B	B	A	A	A	C	A	B	B	B	A
POTASSIUM HYDROXIDE-DILUTE (HOT)	B	A	B	A	B	A	B	B	D	B	B	B	B	A
POTASSIUM IODIDE	C	B	C	B	C	A	A	A	A	A	C	B	C	A
POTASSIUM NITRATE	B	A	B	A	B	A	A	A	A	A	B	A	B	A
POTASSIUM PERMANGANATE	A	A	A	A	A	A	A	A	A	C	A	A	A	B
POTASSIUM SULFATE	B	A	B	A	B	A	A	A	A	C	B	A	B	B
POTASSIUM SULFIDE (10%)	C	B	C	B	C	A	A	A	A	A	C	B	C	D
POTASSIUM SULFITE (10%)	D	A	D	A	D	A	A	A	A	A	D	A	D	D
PRODUCER GAS	B	A	B	A	B	A	A	A	A	A	B	A	B	A
PROPANE	A	A	A	A	A	A	A	A	A	A	A	A	A	A
PROPLENE	-	A	-	A	-	-	-	-	A	-	-	A	A	A
PROPYL ALCOHOL	A	A	A	A	A	A	A	A	A	A	A	A	A	A
PROPYLENE GYLCOL	A	A	A	A	A	A	A	A	A	A	A	A	A	A
PYROGALLIC ACID	B	B	B	B	B	A	A	A		D	B	B	B	B
QUENCH OIL (WATER SOLUBLE)	A	A	A	A	A	A	A	A	B	B	A	A	A	-
RESINS-ROSINS	C	A	C	A	C	A	A	A		B	C	A	C	A
ROAD TAR	A	A	A	A	A	A	A	A	A	B	A	A	A	A
ROOF PITCH	A	A	A	A	A	A	A	A	A	B	A	A	A	A
RUBBER LATEX EMULSIONS	B	A	B	A	B	A	A	A	A	A	B	A	B	-
RUBBER SOLVENT	A	A	A	A	A	A	A	A	D	B	A	A	A	A
SALAD OIL	C	B	C	B	C	A	A	A	A	A	C	B	C	B
SALICYLIC ACID	D	A	D	A	D	A	A	A	A	B	D	A	D	A
SALT	C	B	C	B	C	A	A	A	A	A	C	B	C	A
SEA WATER	D	A	D	A	D	A	A	A	A	A	D	A	D	A
SHELLAC (BLEACHED)	A	A	A	A	A	A	A	A	D	B	A	A	A	A
SHELLAC (ORANGE)	A	A	A	A	A	A	A	A	D	B	A	A	A	A
SILICONE OILS	A	A	A	A	A	A	A	A	A	A	A	A	A	A
SILVER NITRATE	D	B	D	B	D	A	A	A	A	B	D	B	D	D
SOAP SOLUTIONS (STEARATES)	A	A	A	A	A	A	A	A	A	A	A	A	A	A
SODIUM ACETATE	B	B	B	B	B	A	A	A	D	B	B	B	B	B
SODIUM ALUMINATE	C	A	C	A	C	A	A	A	A	A	C	A	C	A
SODIUM BICARBONATE	C	B	C	B	C	A	A	A	A	A	C	B	C	B
SODIUM BISULFATE (10%)	D	A	D	A	D	A	A	A	A	A	D	A	D	B
SODIUM BISULFITE (10%)	D	D	D	D	D	A	A	A	A	A	D	D	D	B
SODIUM BORATE	C	D	C	D	C	A	A	A	A	A	C	D	C	B
SODIUM BROMIDE (10%)	C	B	C	B	C	A	A	A	A	A	C	B	C	B
SODIUM CARBONATE	B	B	B	B	B	A	A	A	A	A	B	B	B	A
SODIUM CHLORATE	C	B	C	B	C	A	A	A	A	A	C	B	C	B
SODIUM CHLORIDE	C	B	C	B	C	A	A	A	A	A	C	B	C	A
SODIUM CHROMATE	B	B	B	B	B	A	A	A	A	D	B	B	B	B
SODIUM CYANIDE (10%)	A	A	A	A	A	A	A	A	A	B	A	A	A	B
SODIUM FLUORIDE	D	B	D	B	D	A	A	A	A	A	D	B	D	A
SODIUM HYDROXIDE 20% (COLD)	A	A	A	A	A	A	A	A	B	A	A	A	A	A
SODIUM HYDROXIDE 20% (HOT)	C	B	C	B	C	A	B	B	C	B	C	B	C	A
SODIUM HYDROXIDE 50% (COLD)	B	B	B	B	B	A	C	C	C	A	B	B	B	A
SODIUM HYDROXIDE 50% (HOT)	B	B	B	B	B	A	C	C	C	B	B	B	B	A
SODIUM HYDROXIDE 70% (COLD)	C	B	C	B	C	A	C	C	C	C	C	B	C	B
SODIUM HYDROXIDE 70% (HOT)	B	B	B	B	B	A	D	D	C	C	B	B	B	B
SODIUM HYPOCHLORIDE	D	D	D	D	D	A	A	A	A	D	D	D	D	D
SODIUM METAPHOSPHATE	A	B	A	B	A	A	A	A	A	A	A	B	A	B
SODIUM METASILICATE (HOT)	D	A	D	A	D	A	A	A	-	A	D	A	D	A
SODIUM METASILICATE (COLD)	C	A	C	A	C	A	A	A	-	A	C	A	C	A

(-) - Not tested.

VTFFP - Virgin TFE Packing.

Note: All ladings at ambient temperatures except as noted.

WKM DYNASEAL MATERIAL SELECTION GUIDE (CONTINUED)

LADING	STD BDY CS	STD BDY S1	STD BDY CS2	STD BDY S8	SPL BDY CS3	SPL 01	STD 42	SPL 18	SPL 07	STD 43	STD INT CS	STD INT S1	SPL INT S2	SPL INT ML
SODIUM NITRATE	B	B	B	B	B	A	A	A	-	C	B	B	B	B
SODIUM PERBORATE	B	B	B	B	B	A	A	A	A	A	B	B	B	B
SODIUM PEROXIDE	C	B	C	B	C	A	A	A	A	B	C	B	C	B
SODIUM PHOSPHATE (DIBASIC)	B	B	B	B	B	A	A	A	A	A	B	B	B	B
SODIUM PHOSPHATE (TRIBASIC)	B	B	B	B	B	A	A	A	A	A	B	B	B	B
SODIUM SILICATE	A	A	A	A	A	A	A	A	A	A	A	A	A	B
SODIUM SILICATE (HOT)	B	B	B	B	B	A	A	A	A	A	B	B	B	B
SODIUM SULFATE NA ₂ S04	B	A	B	A	B	A	A	A	A	A	B	A	B	A
SODIUM SULFIDE (HOT)	C	B	C	B	C	A	A	A	A	A	C	B	C	B
SODIUM SULFIDE NA ₂ S02	B	B	B	B	B	A	A	A	A	A	B	B	B	A
SODIUM THIOSULFATE	D	B	D	B	D	A	A	A	A	A	D	B	D	B
SOUR GAS AND OIL	D	D	A	A	A	A	A	A	A	A	D	D	A	A
SOYBEAN OIL	C	A	C	A	C	A	A	A	A	A	C	A	C	A
STANNIC CHLORIDE	D	D	D	D	D	A	A	A	A	B	D	D	D	C
STANNOUS CHLORIDE	D	C	D	C	D	A	A	A	A	D	D	C	D	C
STARCH	A	A	A	A	A	A	A	A	A	A	A	A	A	A
STEAM (212F)	B	A	B	A	B	B	C	A	D	D	B	A	A	A
STEARIC ACID	C	A	C	A	C	A	A	A		B	C	A	C	B
STODDARD SOLVENT	B	B	B	B	B	A	A	A	A	A	B	B	B	B
STYRENE	A	A	A	A	A	B	D	D	D	B	A	A	A	A
SUGAR LIQUIDS	B	A	B	A	B	A	A	A	A	A	B	A	B	A
SULFATE, BLACK LIQUORS	C	B	C	B	C	A	A	A	A	B	C	B	C	B
SULFATE, GREEN LIQUORS	C	B	C	B	C	A	A	A	A	B	C	B	C	B
SULFATE, WHITE LIQUORS	D	B	D	B	D	A	A	A	A	B	D	B	D	B
SULFURIC ACID (0-7%) (VTFEP)	D	B	D	B	D	A	A	A	A	D	D	B	D	B
SULFURIC ACID (100%) H ₂ S04 (VTFEP)	B	B	B	B	B	A	A	A	B	D	B	B	B	D
SULFURIC ACID (20%) (VTFEP)	D	D	D	D	D	A	A	A	A	D	D	D	D	B
SULFURIC ACID (50%) (VTFEP)	D	D	D	D	D	A	A	A	A	D	D	D	D	B
SULFUROUS ACID	D	D	D	D	D	A	A	A	A	D	D	D	D	D
SULPHUR	B	A	B	A	B	A	A	A	A	C	B	A	B	A
SULPHUR DIOXIDE (DRY)	B	A	B	A	B	A	A	A	A	A	B	A	B	A
SULPHUR TRIOXIDE (DRY)	B	B	B	B	B	A	A	A	A	B	B	B	B	B
SYNTHESIS GAS	B	B	B	B	B	A	A	A	A	A	B	B	B	A
TALL OIL	B	B	B	B	B	A	A	A	A	A	B	B	B	A
TANNIC ACID	B	B	B	B	B	A	A	A	A	A	B	B	B	B
TAR - TAR OIL	A	A	A	A	A	A	A	A	A	B	A	A	A	A
TARTARIC ACID	D	B	D	B	D	A	A	A	A	B	D	B	D	B
TETRAETHYL LEAD	C	B	C	B	C	A	A	A	A	B	C	B	C	A
TITANIUM TETRACHLORIDE T1-CL4	-	-	-	-	-	-	-	A	-	-	-	-	-	-
TITANIUM TRICHLORIDE T1-CL3	-	-	-	-	-	-	-	A	-	-	-	-	-	-
TOLUENE - TOLUOL	A	A	A	A	A	A	A	A	A	B	A	A	A	A
TOMATO JUICE	C	A	C	A	C	A	A	A	A	A	C	A	C	A
TRANSFORMER OIL	A	A	A	A	A	A	A	A	A	A	A	A	A	A
TRIBUTYL PHOSPHATE	A	A	A	A	A	A	A	A	D	B	A	A	A	A
TRICHLOROETHYLENE	B	B	B	B	B	A	A	A	B	B	B	B	B	A
TUNG OIL	B	A	B	A	B	A	A	A	A	A	B	A	B	C
TURPENTINE	B	A	B	A	B	A	A	A	A	A	B	A	B	B
UREA	C	B	C	B	C	A	A	A	-	-	C	B	C	A
VARNISH	C	A	C	A	C	A	A	A	B	B	C	A	C	A
VEGETABLE OIL, EDIBLE	B	A	B	A	B	A	A	A	A	A	B	A	B	B
VEGETABLE OIL, NON-EDIBLE	B	A	B	A	B	A	A	A	A	A	B	A	B	B
VINEGAR	D	A	D	A	D	A	A	A	A	A	D	A	D	A
WATER, DISTILLED (AREATED)	D	A	D	A	D	A	A	A	A	A	D	A	D	A
WATER, FRESH	C	A	C	A	C	A	A	A	A	A	C	A	C	A
WATER, SEA	D	A	D	A	D	A	A	A	A	A	D	A	D	A
WAX, EMULSIONS	A	A	A	A	A	A	A	A	A	A	A	A	A	-
WAXES	A	A	A	A	A	A	A	A	A	A	A	A	A	A
WHISKEY AND WINE	D	A	D	A	D	A	A	A	A	A	D	A	D	A
XYLENE (DRY)	A	A	A	A	A	A	A	A	A	A	A	A	A	A
ZINC CHLORIDE	D	D	D	D	D	A	A	A	A	C	D	D	D	B
ZINC HYDROSULFITE	A	A	A	A	A	A	A	A	A	D	A	A	A	B
ZINC SULFATE	D	B	D	B	D	A	A	A	A	D	D	B	D	B

(-) - Not tested.

VTFEP - Virgin TFE Packing.

Note: All ladings at ambient temperatures except as noted.

TRADEMARK INFORMATION

WKM® is a registered trademark which is owned by Cameron.

This document contains references to registered trademarks or product designations, which are not owned by Cameron.

Trademark	Owner	Common Name	Comparable Cameron Abbreviated Name (in Trim Charts)
AFLAS	Asahi Glass Company	TFE Propylene	FXM
CELCON	Hoechst Celanese Corporation		
DELTRIN	E.I. DuPont De Nemours & Company		
PEEK	Victrex PLC Corp United Kingdom	Polyetheretherketone	PK
STELLITE	Stoody Deloro Stellite, Inc.		
TEFLON	E.I. DuPont De Nemours & Company	Poly Tetra Fluoro Ethylene	PTFE
VITON	DuPont Dow Elastomers L.L.C.	Fluoroelastomer	FKM
17-4PH	Armco Advanced Materials Corp.	17-4PH Stainless Steel	Type 630
		Electroless Nickel Plating	ENP

**VALVES & MEASUREMENT**

3250 Briarpark Drive, Suite 300
Houston, Texas 77042
USA Toll Free 800 323 9160

For the most current contact and location information go to: www.c-a-m.com